

2018

SPYDER

RIDING GEAR,
ACCESSORIES
GENUINE PARTS
INTERNATIONAL EDITION

2018 CAN-AM SPYDER - INTERNATIONAL EDITION

RIDING GEAR, ACCESSORIES & GENUINE PARTS

CANAMSPYDER.COM



ski-doo **LYNX** **SEA-DOO** **EVINRUDE** **ROTAX** **can-am**



can-am 



GET IN THE SPYDER LANE.

Inspiration, imagination, and all that's possible - they're what drive us. Our Can-Am Spyder is proof that we never sit still, and our accessories, riding gear, and sportswear speak volumes about our commitment to endlessly enhancing the experience for all. And it all starts here... more than 104 pages filled with ideas and possibilities.

We've gone farther to include everyone who wakes up mornings hoping to climb aboard their Can-Am Spyder. We're always listening to the countless Can-Am Spyder enthusiasts who help power our innovation, inspiring us to create newer, more compelling products.

Designed for men and women alike, we've got something for every rider geared towards whatever destination you call your own. If it's comfort and fashion you're looking for, or simply want the ultimate in fit, function, style or performance it's all here. Easy to understand, and easier than ever to love.

Add our exclusive 4U Guide to complete accessory customization and it's clear: this is going to be an unforgettable year of exploration and exhilaration.

This is the place where you begin to make our Can-Am Spyder yours. We may build it, but it's fueled by your imagination.

Welcome to the all-new, all yours, ultra-enhanced Can-Am Spyder experience.

Visit your preferred dealer and start enhancing your Can-Am Spyder experience.

RIDING GEAR 2

Men's & Ladies' Jackets	4
Jackets Technology	10
Jackets - Regular Size Collection	12
Jackets - Plus Size Collection	15
Rain Gear	18
Technical Wear	19
Helmets & Accessories	20
Communication Systems	26
Footwear	28
Protective Guards	28
Bags	29
Gloves	30

SPORTSWEAR 32

Mens'	34
Ladies'	36

BRP LIMITED WARRANTY 38

SIZING CHART 39

ACCESSORIES 40

4U Guide	42
----------	----

CUSTOMIZED VEHICLES

F3-S	46
F3-S	47
F3 Limited	48
F3-T	49
RT	74
RT Limited	75

SPYDER F3 ACCESSORIES

UFit System	50
U-FIT	51
Handlebars	51
Brake & Shifter Linkages	52
Idle Pulley & Footboards	53
U-FUNCTION	54
Seats & Backrests	55
Windshields & Wind Protection	56
Cargo & Storage	58
Lights & Electrical Accessories	63
U-STYLE	65
Wheels	65
Fenders	66
Custom Accessories	67
Decals	68
U-PERFORMANCE	69
Shocks	69
Silencers	71

SPYDER RT ACCESSORIES

U-FIT	76
Idle Pulley & Handlebars	76
U-FUNCTION	77
Seats & Backrests	77
Windshields & Wind Protection	78
Cargo & Storage	80
Lights & Electrical Accessories	82

U-STYLE 84

Wheels	84
Fenders	85
Custom Accessories	86
U-PERFORMANCE	88
Shocks & Silencers	88

SPYDER RS & ST ACCESSORIES

U-FUNCTION	91
Seats & Backrests	91
Windshields & Wind Protection	91
Cargo & Storage	93
Lights & Electrical Accessories	94
U-STYLE	96
Wheels	96
Fenders	98
Custom Accessories	99
U-PERFORMANCE	100
Shocks	100
Silencers	101

COVERS 102

PARTS 104

OILS & MAINTENANCE 106



GOING GLOBAL

This catalog, global in nature, shares BRP's parts, accessories and clothing product offering. Some products may not be available in your country, due to different climates, local certifications and/or legal requirements. Contact your BRP dealer for local specifics.

© 2017 Bombardier Recreational Products Inc. (BRP). All rights reserved. ®, ™ and the BRP logo are trademarks of BRP or its affiliates. 3M and SCOTCHLITE are trademarks of 3M Company. BLUETOOTH is a registered trademark of Bluetooth SIG. CLARINO is a trademark of Kuraray Co. Ltd. DRI-RELEASE is a registered trademark of Optimer Inc. FOX and PODIUM are trademarks of FOX Racing Canada. HIPORA is a registered trademark of Kolon Industries. IPOD and IPAD are registered trademarks of Apple Inc. TEFLON, TEFLON HT and KEVLAR are registered trademarks of E.I. DuPont de Nemours & Co. LEXAN is a registered trademark of SABIC Innovative Plastics Holding BV. MAKROLON is a registered trademark of Bayer Material Science AG. PINLOCK is a registered trademark of Pinlock Group B.V. MONOKEY is a registered trademark of GIVI SRL. NCOM SYSTEM and NOLAN are registered trademarks of Nolan Helmets S.P.A. NGK is a registered trademark of NGK Spark Plugs Ltd. OUTDRY is a registered trademark of Outdry Technologies Corporation. PRIMALOFT GOLD is a registered trademark of Albany International Corp. QUANTUM is a trademark of National Cycle Inc. RAM is a registered trademark of RAM Mounting Systems Inc. SENA is a trademark of Sena Technologies, Inc. SILICONE is a registered trademark of Dow Corning Corporation. TECHNO GI is a trademark of TECHNOGI spa. THERMOLITE is a registered trademark of INVISTA for durable fabrics. VELCRO is a registered trademark of Velcro Industries. X-STATIC is a registered trademark of Noble Biomaterials Europe srl. YKX is a registered trademark of YKX Corporation. YUASA is a registered trademark of Yuasa Batteries Inc. GARMIN and ZUMO are trademarks of Garmin Ltd. AKRAPOVIC EXHAUST SYSTEM TECHNOLOGY is a registered trademark of Akrapovic d.d. SHAD is a trademark of NAD S.L. CYCLOPS is a registered trademark of CyclopsGear. RoadThunder and MTX are registered trademarks of MTX Audio. Ogio is a registered trademark of Madison, a division of H Young Ltd. All other trademarks are the property of their respective owners. All vehicles presented in this brochure are fully accessorized and may differ from what is available in stores. Prices, if shown, are based on Manufacturer Suggested Retail Prices. Dealers may sell for a different price. For Canada & US taxes are not included. Depending on location, products are distributed by BRP US Inc., Bombardier Recreational Products Inc., BRP European Distribution SA, BRP Finland Oy, BRP Australia Pty Ltd., BRP Mexican Distribution, BRP Japan Ltd., BRP Brasil Motorsports Ltda or Bombardier Recreational Products Motores da Amazonia Ltda. BRP reserves the right, at any time, to discontinue or change specifications, prices, designs, features, equipment without incurring obligation.

RIDING GEAR

LIFE'S BETTER WITHOUT LIMITS.

Look beyond the horizon, to all of those unseen, unexplored destinations that never seem to stop calling you. Listen to your heart and head out... anywhere. In fact, the farther the better. Don't just live your dreams; ride them - intensely, completely and without hesitation. When you're one with your Can-Am Spyder, then anywhere you're headed is home.



LOOK AS GOOD AS YOU RIDE.



JOSH LEATHER JACKET 440740
HANNA JACKET 440735



HANNA JACKET 440735
LADIES' CRUISE JACKET 440734
JOSH LEATHER JACKET 440740



HANNA JACKET 440735

JOSH LEATHER JACKET 440740



EMMA PLUS MESH JACKET 440739
BRUCE PLUS JACKET 440678

RUSSELL MESH JACKET 440676
LADIES' CRUISE PLUS JACKET 440752
MEN'S VOYAGER JACKET 440641



EMMA PLUS MESH JACKET 440739



COOPER PLUS JACKET 440753

MEN'S CRUISE PLUS JACKET 440751
NICKY PLUS JACKET 440679
RUSSELL MESH JACKET 440676



LADIES' CRUISE PLUS JACKET 440752
MEN'S CRUISE PLUS JACKET 440751
KATE MESH JACKET 440736



BRUCE PLUS JACKET 440678



KATE MESH JACKET 440736
NICKY PLUS JACKET 440679



FIND THE RIGHT JACKET

WHICH JACKET SUITS YOU BEST?

Hit the road in style, your style. There's a Can-Am jacket that fits you in every way and is loaded with the features you want. Whether you choose mesh jackets for keeping cool, leather jackets for their classic look, or ultra-durable nylon for serious road trips, we've got you covered. They're all available in a range of regular and plus sizes, for men and women, and are designed to work with our exclusive weather-beating rain gear. All you have to do is choose, and we've made that easier than ever. Whatever your destination - and whatever your riding style - you can be sure we've got a jacket that suits you perfectly.



USE THIS GUIDE TO FIND THE FEATURES YOU WANT BY LOOKING FOR THE CORRESPONDING SYMBOL AMONG OUR EXTENSIVE COLLECTION OF JACKETS.



100% WATERPROOF
To keep dry in all conditions.



WATER RESISTANT
To keep dry in light rain conditions or during short rides.



WINDPROOF
To protect from air infiltration.



REMOVABLE INSULATED LINING
To adapt to the current temperature. Wear when cold, remove when warm.



POCKETS FOR REMOVABLE PROTECTORS
Pouches to insert removable protectors.



ADJUSTED FIT
Fits closer to the body.



RELAXED FIT
Looser fit for relaxed riding position.



RPM



RPM MAX

HIGH PERFORMANCE GEAR WITH RPM TECHNOLOGY

Critical seams and logos are sealed, so water can't enter through potential openings.



100% of seams and logos are sealed, so water can't enter through potential openings.

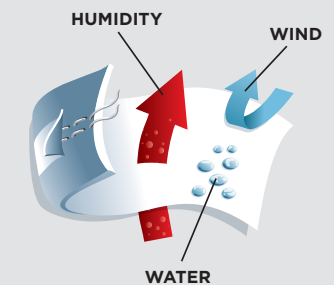

RPM & RPM MAX coatings keep wind and air out and still allow perspiration to escape.



REGULAR SIZE COLLECTION

TEXTILE

▶ Learn everything about the technology built into the Cruise Jackets.
Go to: canamspyder.com

MEN'S & LADIES' CRUISE JACKETS



FEATURES

- Teflon-treated highly wear-resistant fabric.
- Shaped sleeves.
- Action pleat gussets at back armhole for extra comfort and ease of movement.
- Critical seams sealed.
- Chest and back ventilation.
- Multi-adjustable biceps, wrists and waist openings.
- Reflective details at back.
- May require rain suit in heavy rain conditions.

Shell: Nylon, Other Fabric
Insulation: Polyester

BENEFITS

- Outstanding ventilation, lightweight for extra comfort.
- Breathable to keep you dry.
- Excellent flexibility and rider fit.
- Wind and water protection.
- Ultra-durability and wear resistance.
- Convenience, good practicality, and nighttime visibility.



NEW MEN'S CRUISE JACKET
440733 · S, M, L, XL, 2XL, 3XL · Charcoal Grey (07)



NEW LADIES' CRUISE JACKET
440734 · XS, S, M, L, XL, 2XL · White (01)



HANNA JACKET



FEATURES

- Teflon-treated highly wear-resistant fabric.
- Shaped sleeves.
- Critical seams sealed.
- Chest and back ventilation.
- Multi-adjustable biceps, forearms, wrists and waist openings.
- Reflective back collar.
- May require rain suit in heavy rain conditions.

Shell: Nylon
Insulation: Polyester

BENEFITS

- Outstanding ventilation, lightweight for extra comfort.
- Breathable to keep you dry.
- Excellent flexibility and rider fit.
- Wind and water protection.
- Ultra-durability and wear resistance.
- Convenience, good practicality, and nighttime visibility.



HANNA JACKET
440735 · XS, S, M, L, XL, 2XL · Khaki (05), Black (90)

Some products may not be available or homologated in your region. Contact your dealer for more information.

LEATHER

JOSH LEATHER JACKET



FEATURES

- Full grain distressed vintage cowhide leather.
- Shaped sleeves.
- Shell: Cow Leather
- Insulation: Cotton

BENEFITS

- Flexible for better comfort and ease of movement.
- Stylish, eye-catching design.
- Convenience and practicality.



JOSH LEATHER JACKET
440740 · S, M, L, XL, 2XL, 3XL · Black (90)



PLUS SIZE COLLECTION

MESH



Watch the Russell and Kate Mesh Jackets' work features.
Go to: canamspyder.com

RUSSELL & KATE MESH JACKETS

FEATURES

- Made of highly breathable mesh.
- No collar.
- Adjustable waist, biceps, forearms and sleeves openings.

- Shaped sleeves.
- 3M[®] reflective details at back.
- Shell: Polyester, Nylon
- Insulation: Polyester

BENEFITS

- Lightweight comfort with outstanding breathability.
- Excellent flexibility and rider fit.
- Convenience, practicality, and nighttime visibility.



RUSSELL MESH JACKET
440676 · S, M, L, XL, 2XL, 3XL · Black (90)



KATE MESH JACKET
440736 · XS, S, M, L, XL, 2XL · Black (90)



TEXTILE

MEN'S & LADIES' CRUISE PLUS JACKETS



FEATURES

- Teflon-treated highly wear-resistant fabric.
- Shaped sleeves.
- Action pleat gussets at back armhole for extra comfort and ease of movement.
- Critical seams sealed.

- Chest, biceps and back ventilation.
- Adjustable biceps openings.
- Reflective back collar.
- May require rain suit in heavy rain conditions.
- Shell: Nylon, Other Fabric
- Insulation: Polyester

BENEFITS

- Outstanding ventilation and extra roominess, for comfort.
- Breathable to keep you dry.
- Excellent flexibility and rider fit.
- Wind and water protection.
- Ultra-durability and wear resistance.
- Convenience, good practicality, and nighttime visibility.



MEN'S CRUISE PLUS JACKET
440751 · L PLUS, XL PLUS, 2XL PLUS, 3XL PLUS, 4XL PLUS, 5XL PLUS
Black (90)



LADIES' CRUISE PLUS JACKET
440752 · M PLUS, L PLUS, XL PLUS, 2XL PLUS, 3XL PLUS
Black (90)





MEN'S VOYAGER JACKET



FEATURES

- Parka style jacket.
- Teflon HT-treated highly wear-resistant fabric.
- Shaped sleeves.
- Action pleat gussets at back armhole for extra comfort and ease of movement.
- All seams sealed.
- Multi-adjustable biceps, forearms and waist.
- Chest, shoulder and back ventilation.
- 3M reflective details.
- May require rain suit in heavy rain conditions.
- Shell: Nylon
- Insulation: Polyester

BENEFITS

- Outstanding ventilation and extra roominess, for comfort.
- Keeps you dry and warm all day.
- Excellent flexibility and rider fit.
- Wind and water protection.
- Ultra-durability and wear resistance.
- Convenience, good practicality, and nighttime visibility.



MEN'S VOYAGER JACKET
440641 - S, M, L, XL, 2XL, 3XL - Black (90)

COOPER PLUS & HANNA PLUS JACKETS



FEATURES

- Teflon-treated highly wear-resistant fabric.
- Shaped sleeves.
- Action pleat gussets at back armhole for extra comfort and ease of movement.
- Critical seams sealed.
- Underarm ventilation (Cooper Plus Jacket).
- Reflective back collar.

- Chest, biceps and back ventilation (Hanna Plus Jacket).
- Multi-adjustable biceps, forearms, wrists and waist openings.
- May require rain suit in heavy rain conditions.
- Shell: Nylon
- Insulation: Polyester

BENEFITS

- Outstanding ventilation and extra roominess, for comfort.
- Breathable to keep you dry.
- Excellent flexibility and rider fit.
- Wind and water protection.
- Ultra-durability and wear resistance.
- Convenience, good practicality, and nighttime visibility.



COOPER PLUS JACKET
440753 - L PLUS, XL PLUS, 2XL PLUS, 3XL PLUS, 4XL PLUS, 5XL PLUS - Khaki (05), Black (90)



HANNA PLUS JACKET
440754 - M PLUS, L PLUS, XL PLUS, 2XL PLUS, 3XL PLUS - Khaki (05), Black (90)

BRUCE PLUS & NICKY PLUS JACKETS



FEATURES

- Teflon-treated highly wear-resistant fabric.
- Shaped sleeves.
- Action pleat gussets at back armhole for extra comfort and ease of movement.
- Critical seams sealed.
- Chest and back ventilation.
- Multi-adjustable biceps, forearms, wrists and waist openings.
- Reflective back collar.
- May require rain suit in heavy rain conditions.
- Shell: Nylon
- Insulation: Polyester

BENEFITS

- Outstanding ventilation and extra roominess, for comfort.
- Breathable to keep you dry.
- Excellent flexibility and rider fit.
- Wind and water protection.
- Ultra-durability and wear resistance.
- Convenience, good practicality, and nighttime visibility.



BRUCE PLUS JACKET
440678 - XL PLUS, 2XL PLUS, 3XL PLUS, 4XL PLUS, 5XL PLUS - Khaki (05) - Black (90)



NICKY PLUS JACKET
440679 - L PLUS, XL PLUS, 2XL PLUS, 3XL PLUS, 4XL PLUS - Beige (02) - Black (90)

MESH

Learn more about the Shaun and Emma Plus Mesh Jackets.
Go to: canamspyder.com

SHAUN PLUS & EMMA PLUS MESH JACKETS



FEATURES

- Made of highly breathable mesh.
- No collar.
- Shaped sleeves.
- Action pleat gussets at back armhole for extra comfort and ease of movement.

- Adjustable waist, biceps and sleeves openings.
- 3M reflective details at back.
- Shell: Polyester, Nylon
- Insulation: Polyester

BENEFITS

- Outstanding breathability and extra roominess, for comfort.
- Excellent flexibility and rider fit.
- Convenience, practicality, and nighttime visibility.



SHAUN PLUS MESH JACKET
440738 - L PLUS, XL PLUS, 2XL PLUS, 3XL PLUS, 4XL PLUS, 5XL PLUS - Black (90)



EMMA PLUS MESH JACKET
440739 - M PLUS, L PLUS, XL PLUS, 2XL PLUS, 3XL PLUS - Black (90)

RAIN GEAR

▶ Learn the features and technologies of the Rain Jacket.
Go to: canamspyder.com



RAIN JACKET

- Made of waterproof and windproof Teflon-treated light PVC nylon.
- Balaclava hood, sewn into the jacket, for use under the helmet while riding, to avoid water infiltration during a downpour.
- Back ventilation for moisture evacuation.
- Shaped sleeves.
- Two Velcro® waist pockets with flap.
- Reflective details at front and back.
- Jacket folds into back pocket.
- To wear over riding jacket, order one size up or try it on over your riding jacket to ensure it fits.

Shell: Waterproof Nylon
440568
XS, S, M, L, XL, 2XL, 3XL
Black (90)



RAIN PANTS

- Elasticized waist.
- Velcro-hemmed wide side leg gusset for slipping pants on while wearing boots.
- Elastic at bottom leg to prevent pants from riding up.
- Folds into jacket's back pocket for easy traveling.
- To wear the pants over clothes, order one size up or try them on over your clothes to ensure they fit.
- Ladies: order one size smaller.

Shell: Waterproof Nylon
441501
XS, S, M, L, XL, 2XL, 3XL
Black (90)



TECHNICAL WEAR



NEW WINDPROOF FLEECE

- Windproof polyester zip up jacket.
- Also ideal for wearing as an insulating first layer on cold days.
- Two zippered hip pockets.
- Reflective details at front and back.

Polyester
Men's - 454056 - S, M, L, XL, 2XL, 3XL
Denim Blue (79), Black (90)
Ladies' - 454055 - XS, S, M, L, XL, 2XL, 3XL
Warm Grey (15), Black (90)



Men's

Ladies'

CAN-AM TECHNICAL JACKET

- Soft shell combines light insulation, breathability and weatherproofing.
- 4-way stretch fabric.
- Also ideal for wearing as an insulating first layer on cold days.
- Reflective details.
- Two hand pockets with YKK® water-resistant zipper.
- Back venting.
- Pre-shaped sleeves.
- Adjustment at hem.

Polyester, Spandex
Men's - 453755 - S, M, L, XL, 2XL, 3XL - Black (90)
Ladies' - 453754 - XS, S, M, L, XL, 2XL - Black (90)



Men's



Ladies'

HELMETS & ACCESSORIES

▶ Learn everything about the technology built into the Can-Am helmets by Nolan. Go to: canamspyder.com



WHEREVER YOU GO IS THE DESTINATION.

CAN-AM N21 DURANGO OPEN FACE HELMET 448481 · DOT, 448482 · ECE

CAN-AM N104 ABSOLUTE MODULAR HELMET 448496



CAN-AM N40-5 GT CROSSOVER HELMET 448569 - DOT, 448570 - ECE



CAN-AM N104 ABSOLUTE MODULAR HELMET 448496

Helmets shown are not available in Brazil. Contact your dealer for local helmets.



CROSSOVER HELMETS

CAN-AM N40-5 GT CROSSOVER HELMET

FEATURES

- **N-Com' B5 Communication System-ready.**
- Super-strong lightweight, aerodynamically-tuned polycarbonate shell with integrated spoiler.
- Exclusive Crossover technology.
- Optically-correct UV400 face shield protects the entire face while offering a large eye port and can be changed in seconds.
- Exclusive Vision Protection System (VPS) features a scratch-resistant, antifogging, sunshield that raises or lowers in an instant.
- Innovative AirBooster' multi-vent airflow system.
- Fully removable, washable Clima-Comfort' liner, adjustable cheek pads.
- Velour-padded chinstrap with Microlock2 quick-release retention system.
- Removable protective chin guard with air intake.
- Includes all necessary accessories: chin guard plugs, side covers and helmet storage pouch.
- ECE version not available in North America.

Shell: Lexan Polycarbonate

BENEFITS

- Improved performance, stability and excellent high-impact resistance.
- Ultra-convenient accessory addition or replacement, maintenance, and customization.
- Added safety, exceptional field of vision and convenience.
- Protection against sun, glare, and condensation.
- Exceptional ventilation for improved temperature control.
- Anti-bacterial, anti-fungal and moisture wicking for added comfort and hygiene.
- Convenience and comfort.
- Wind noise reduction.

DOT ECE22.05



ONE HELMET, FOUR LOOKS

QUICK-CHANGE ACCESSORIES ALLOW YOU TO CUSTOMIZE THE LOOK AND FEATURES FOR EVERY RIDE.



NEW CAN-AM N40-5 GT CROSSOVER HELMET

448569 - DOT
XS, S, M, L, XL, 2XL - White (01), Magnesium (24), Black (90)
448570 - ECE
XS, S, M, L, XL, 2XL - White (01), Black (90)

OPEN FACE HELMET

CAN-AM N21 DURANGO OPEN FACE HELMET

FEATURES

- Minimalist retro design.
- Super-strong lightweight Lexan' polycarbonate shell.
- Replaceable anti-scratch inner visor.
- Fully removable, washable liner.
- Microlock' quick-release chin strap.
- Complete with protective storage pouch.
- ECE version not available in North America.

Shell: Lexan Polycarbonate

BENEFITS

- Superior quality and great look.
- High-impact resistance and comfort.
- Good visibility and practicality.
- Anti-bacterial, anti-fungal and moisture wicking for added comfort and hygiene.
- Added safety and convenience.

DOT ECE22.05



CAN-AM N21 DURANGO OPEN FACE HELMET

448481 - DOT
448482 - ECE
S, M, L, XL, 2XL, 3XL - Matte Black (93)



CAN-AM N44 EVO CROSSOVER HELMET

FEATURES

- **N-Com B5 Communication System-ready.**
- Redesigned fully removable, washable Clima-Comfort liner.
- 6-in-1 design, super-strong lightweight, aerodynamically-tuned Lexan polycarbonate shell with integrated spoiler.
- Exclusive Crossover technology.
- Optically-correct UV400 face shield with 3-position vent protects the entire face while offering a large eye port and can be changed in seconds.

- Exclusive Vision Protection System (VPS) feature a scratch-resistant, antifogging, sunshield that raises or lowers in an instant.
- Innovative AirBooster multi-vent airflow system and hot air extractor.
- Velour-padded chinstrap with Microlock2 quick-release retention system and adjustable cheek pads.
- Includes all necessary accessories: pinlock antifog insert, peak, side covers, chin guard plugs and helmet storing pouch.

Shell: Lexan Polycarbonate

BENEFITS

- Improved performance, stability and excellent high-impact resistance.
- Ultra-convenient accessory addition or replacement, maintenance and customization.
- Added safety, exceptional field of vision, and convenience.
- Protection against sun, glare and condensation.
- Exceptional ventilation for unsurpassed temperature control in hot weather.
- Antibacterial, antifungal and moisture wicking for added comfort and hygiene.
- Safety, comfort and wind noise reduction.

DOT

ONE HELMET, SIX LOOKS

QUICK-CHANGE ACCESSORIES ALLOW YOU TO CUSTOMIZE THE LOOK AND FEATURES FOR EVERY RIDE.



CAN-AM N44 EVO CROSSOVER HELMET
448495 · DOT · XS, S, M, L, XL, 2XL, 3XL · Matte Black (93)



Helmets shown are not available in Brazil. Contact your dealer for local helmets.



MODULAR HELMET

CAN-AM N104 ABSOLUTE MODULAR HELMET

FEATURES

- **N-Com B5 Communication System-ready.**
- Removable, washable and redesigned monobloc cheek pads with integrated chin straps.
- Eyewear Adaptive system marked with red inserts on comfort padding.
- Super-strong lightweight, aerodynamically-tuned Lexan polycarbonate shell with integrated spoiler.
- Optically-correct UV400 face shield with 3-position vent protects the entire face while offering a large eye port and can be changed in seconds.
- Pivoting chin bar.

- Exclusive Vision Protection System (VPS) feature a scratch-resistant, antifogging, sunshield that raises or lowers in an instant.
- Eyewear compatible.
- Innovative AirBooster multi-vent airflow system and chin bar vents.
- Fully removable, washable Clima-Comfort liner and cheek pads.
- Velour-padded chinstrap with Microlock2 quick-release retention system and dual-action Centromatic® release system and chin curtain.
- Complete with Pinlock antifog insert, wind protector with reflective panel and helmet storing pouch.

Shell: Lexan Polycarbonate

BENEFITS

- Improved performance, stability and excellent high-impact resistance.
- Added safety, exceptional field of vision, convenience and versatility.
- Protection against sun, glare and condensation.
- Exceptional ventilation for improved temperature control.
- Antibacterial, antifungal and moisture wicking for added comfort and hygiene.
- Comfort, wind noise reduction and performance.

DOT



CAN-AM N104 ABSOLUTE MODULAR HELMET
448496 · DOT · XS, S, M, L, XL, 2XL, 3XL
Black (90), White (01)



ENHANCE THE EXPERIENCE.

Get your message across around every curve, into any headwind, and in the noisiest traffic with our in-helmet communications systems. A lot happens when convenience, comfort and cutting-edge technology come together to create effortless communication. Whether you're out for an hour or in it for the long haul our systems ride with you, letting you stay in touch in almost any driving condition.



COMMUNICATION SYSTEMS

USE THIS CHART TO FIND THE COMMUNICATION SYSTEM THAT FITS YOUR NEEDS.

	NOLAN N-COM B5 4484240090	SENA 20S 4482070090 (SINGLE PACK) 4482080090 (DUAL PACK)
FEATURES		
Bluetooth	4.1	4.1
Intercom Distance	0.3 MI (0.5 KM)	1.2 MI (2 KM)
Universal Intercom*	✓	✓
Intercom Connections*	6-WAY**	8-WAY**
Cell Phone and/or GPS and/or MP3 Player Compatible	✓	✓
Advance Noise Control	✓	✓
FM Radio	✓	✓
Voice Command	✓	✓
Helmet Integration	FULLY INTEGRATED (NOLAN'S HELMETS: N40-5, N44 & N104)	EXTERNAL (UNIVERSAL MOUNTING)

*Can be connected via Bluetooth to intercom systems of other brands.

**Way means number of person who can talk together.



NOLAN N-COM B5 COMMUNICATION SYSTEM FOR CAN-AM N40-5, N44 & N104 HELMETS - SINGLE PACK
4484240090

FEATURES

- Designed by Nolan to install easily and to integrate perfectly into Can-Am helmets by Nolan.
- Exclusive N-Com modular communication system delivers freedom, flexibility and impressive expandability.
- Excellent audio quality at any speed with long-ride comfort.
- Enjoy conversations with passengers, other riders, listen to music via your MP3 player, use your smartphone, or operate and interact with your GPS unit - even while the device is charging.
- Fully ECE/ONU 2205 compliant.



SENA 20S BLUETOOTH COMMUNICATION SYSTEM - SINGLE PACK
4482070090

FEATURES

- Super-versatile, water-resistant multi-function Bluetooth communication, navigation and music system designed for outdoor and vehicle sound environment use.
- Driver-to-passenger and driver-to-driver communication at a range over 1.2 miles (2 km).
- Up to 12-hour talk and 10-day stand-by time on a single charge - permits simultaneous charge & play.
- Complete with integrated microphone, wired microphone, wired boom microphone, speakers, plus mp3, earbud and GPS ports.



SENA 20S BLUETOOTH COMMUNICATION SYSTEM - DUAL PACK
4482080090

- 4-way conference, smartphone, intercom-to-phone connection, GPS and mp3 music playback via AVRCP operation, or easy-adjust manual operation with exclusive jog dial.
- Voice-prompt feedback, clear and natural sound quality, individual volume control for each audio source, fully-integrated audio booster delivers optimal sound level - fully firmware-upgradeable.

Some products may not be available or homologated in your region. Contact your dealer for more information.

FOOTWEAR



SPYDER RT RIDING BOOTS

- Perfect for rain or cold weather.
- Water-repellent leather.
- Hipora® waterproof, windproof and breathable membrane with 100% polyester lining padded with open cell foam for better comfort.
- 3M Scotchlite reflective detail on back.
- Sole structure offering a good grip under all conditions.
- Molded nylon ankle guard.
- Molded nylon shin guard backed with shock absorbing material.
- Injected thermoplastic polyurethane toe pad for shifting gears.
- Techno GI® thermoplastic toe cap.
- Pre-formed orthopedic vibration-absorbing sole.
- Anti-crush tempered steel shank.
- Anti-twist sole.
- High-tech rubber composite sole.

444208 - 7, 8, 9, 10, 11, 12, 13 - Black (90)
See p. 39 for European footwear equivalencies.



PROTECTIVE GUARDS



RETRO REFLECTIVE ARMBAND

- To wear on bicep over a jacket to be more visible.
 - Velcro attachment.
 - Meets France retro-reflective equipment legislation.
- Polyester, Spandex, Polyurethane
453674 - One size
Hi-Vis Yellow (26)

REMOVABLE BACK PROTECTOR

- High shock absorbing performance.
 - Maximal comfort.
 - Can be inserted in most Can-Am Spyder jacket inside pouches for extra protection.
- Viscoelastic Polyurethane Foam
447321 - S, L, XL - Black (90)

REMOVABLE ELBOW, KNEE OR SHOULDER PROTECTORS

- Same protectors for elbow, knee or shoulder.
 - Can be inserted in most Can-Am Spyder riding gear inside pouches for extra protection.
 - Sold in pairs.
- Viscoelastic Polyurethane Foam
Men's 447313 - One size Black (90)
Ladies' 447322 - One size Black (90)

BAGS



NEW CAN-AM SLAYER GEAR BAG BY OGIO®

- Large main compartment with easy access to all gear.
 - Large separated boot pocket.
 - Zippered accessory pocket.
 - Easy grab end handles for transport.
 - Detachable shoulder strap.
 - Heavy-duty reinforced base
 - Dimensions: 32" H x 16" W x 18" D (81 cm x 41 cm x 46 cm)
- 4692940090 - Black



NEW CAN-AM URBAN BACKPACK BY OGIO®

- Airport security friendly protective laptop compartment.
 - Padded iPad/tablet/e-reader pocket.
 - Dual side water bottle/accessory holders.
 - Fully adjustable ergonomic shoulder straps.
 - Front pocket with two padded accessory compartments and slip pocket.
 - Dimensions: 19.5" H x 13.5" W x 9.5" D (50 cm x 34 cm x 24 cm).
- 4692930090 - Black



SHAD+ BACKPACK E-83

- Semi-rigid exterior.
 - Secure storage in 2 zippered main compartments.
 - Zippered inner pocket with padded compartments.
 - Adjustable waist and chest straps.
 - Cushioned carry handle.
 - Cover for any helmet size.
 - Adjustable to backpack with 4 metal buckles.
- 219400729 - Black



GLOVES

-  Hot Weather
-  All Weather
-  Cold Weather



LEATHER GLOVES

- Fine grade leather.
- Fit perfectly to offer warmth and protection for mild weather.
- Suede forefinger to wipe visor.
- Padded palm for comfort during longer rides.
- Not EC certified.
- Not available in France.

Shell: Cow Leather
Men's Blake
 446290 · M, L, XL, 2XL, 3XL · Black (90)
Ladies' Veronica
 446291 · S, M, L, XL, 2XL · Black (90)



MECHANIC GLOVES

- Multizone padded palm reduces hand fatigue from shock and vibration.
- Pre-curved design for improved fit.
- Double Clarino® layer at palm and thumb for extra durability and increased comfort.
- Not EC certified.
- Not available in France.

Shell: Nylon, Polyester, Polyurethane, Spandex
446267 · S, M, L, XL, 2XL Black (90)



TECH PLUS GLOVES

- Leather palm with Kevlar® thread stitching.
- Outdry® technology membrane.
- Waterproof and windproof.
- X-STATIC® mesh liner for antibacterial and moisture management.
- Primaloft Gold® insulation at top of hand.
- Leather padded knuckles for better protection.
- Shaped and articulated fingers for maximum grip control.
- Adjustable gauntlet to be worn over or under the jacket.
- Not EC certified.
- Not available in France.

Shell: Nylon, Polyester
 Insulation: Polyester, XT2
446269 · XS, S, M, L, XL, 2XL · Black (90)



 See the features of the Tech Plus Gloves.
 Go to: canamspyder.com



NEW SUMMER MESH GLOVES

- Made from flexible, well-ventilated air mesh fabric.
- Lightweight and comfortable.
- Convenient hook-and-loop wrist closure.
- Pre-curved design for improved fit.
- Durable Clarino palm.
- Silicone fingertips for slip-free grip.
- Direct-injection logos.
- Not EC certified.
- Not available in France.

Men's Shell: Nylon, Polyurethane, Spandex, Polyester
 Ladies' Shell: Nylon, Polyurethane, Polyester, Neoprene, Lycra
Men's
 446296 · S, M, L, XL, 2XL, 3XL · Black (90)
Ladies'
 446299 · XS, S, M, L, XL, 2XL · Black (90)

 Learn more on the all-new Summer Mesh Gloves.
 Go to: canamspyder.com



VSS LEATHER GLOVES

- Hipora® waterproof, windproof and breathable insert.
- Reinforced and padded palm.
- Shaped fingers.
- Articulated and padded knuckle-joint system.
- Silicone palm print for better grip.
- Not EC certified.
- Not available in France.

Shell: Leather
Men's
 446204 · S, M, L, XL, 2XL · Magnesium (24), Black (90)
Ladies'
 446216 · S, M, L, XL · Black (90)



SPORTSWEAR



**SAY HELLO
TO THE NEW YOU.**

You're unique. You always knew that the journey was the destination and it didn't matter who got there first as long as you enjoyed the ride. Confidence, determination and fearlessness have gotten you far, dont stop now.

JESS LONG SLEEVE T-SHIRT 454040
ORIGINAL T-SHIRT 454034
CALIBER POLO 454033



COOPER T-SHIRT 454044
TECHNICAL LONG SLEEVE T-SHIRT 454042



TECHNICAL LONG SLEEVE T-SHIRT 454041



TEES

NEW COOPER T-SHIRT

100% Cotton
454044
S, M, L, XL, 2XL, 3XL
Heather Grey (27),
Blue (80)



NEW TECHNICAL LONG SLEEVE T-SHIRT

· Stretchy technical fabric for extra comfort and ease of movement.
88% Polyester, 12% Elastane
454041
S, M, L, XL, 2XL, 3XL
Charcoal Grey (07),
Blue (80)



NEW ORIGINAL T-SHIRT

100% Cotton
454034
S, M, L, XL, 2XL, 3XL
Heather Grey (27),
Black (90)



NEW LONG SLEEVE ORIGINAL T-SHIRT

100% Cotton
454036
S, M, L, XL, 2XL, 3XL
White (01),
Black (90)



NEW CALIBER POLO

· Moisture wicking polyester to keep you cool and dry.
100% Polyester
454033
S, M, L, XL, 2XL, 3XL
Charcoal Grey (07)



NEW COOPER LONG SLEEVE T-SHIRT

100% Cotton
454039
S, M, L, XL, 2XL, 3XL
Blue (80),
Heather Grey (27)



CAPS

NEW CRUISE CAP

· Adjustable back strap.
· Embossed logo on front panel.
100% Cotton
447316
One size
Black (90), Blue (80)



NEW CLASSIC CAP

· Adjustable back strap.
100% Cotton
447320
One size
Black (90)



NEW CALIBER CAP

· Adjustable back strap.
100% Cotton
447315
One size
Charcoal Grey (07), Black (90)



*Product may differ from picture shown.



TEES

NEW LADIES' TECHNICAL LONG SLEEVE T-SHIRT

Stretchy technical fabric for extra comfort and ease of movement.
88% Polyester, 12% Elastane
454042
S, M, L, XL, 2XL, 3XL
Charcoal Grey (07), Wine (32)



NEW RIDE T-SHIRT

95% Cotton, 5% Elastane
454043
S, M, L, XL, 2XL, 3XL
Wine (32), Black (90)



NEW JESS LONG SLEEVE T-SHIRT

95% Cotton, 5% Elastane
454040
XS, S, M, L, XL, 2XL, 3XL
Wine (32), Teal (74)



NEW ORIGINAL T-SHIRT

95% Cotton, 5% Elastane
454035
XS, S, M, L, XL, 2XL,
White (01), Black (90)



NEW "BLING" T-SHIRT

95% Cotton, 5% Elastane
454037
XS, S, M, L, XL, 2XL, 3XL
White (01), Black (90)



IF WE SELL IT, WE STAND BY IT.

BRP LIMITED WARRANTY*

FOR NEW PARTS, ACCESSORIES AND RIDING GEAR.

2 YEARS LIMITED WARRANTY**

 **GENUINE BRP PARTS AND ACCESSORIES**
installed by you or your authorized BRP dealer

 **AFTERMARKET PRODUCTS SOLD BY BRP**

 **RIDING GEAR**

4 YEAR LIMITED WARRANTY**

 **HELMETS**



GET ALL THE DETAILS FROM YOUR CAN-AM SPYDER DEALER

* Purchased at an authorized BRP dealership / distributor. Other exclusions may apply, see complete limited warranty or contact your Can-Am Spyder authorized dealer.

** Unless otherwise stipulated or required by law.

This limited warranty does not apply to factory installed accessories. This limited warranty does not apply on Evinrude parts and accessories.

Some products may not be available or homologated in your region. Contact your dealer for more information.

HOW TO MEASURE

For best results, have someone else take measurements. Measure body in underwear. Tape must be snug but not tight. If measurements fall between two sizes, order the larger size.

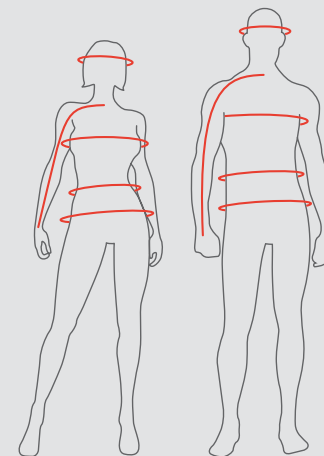

HEAD

Around your head, from the center of the forehead, above the ears and over the natural bump at the back of the head.

CHEST/BUST

Measure under your arms, around the fullest part of your chest.

WAIST

Measure around your natural waistline, keeping one finger between the tape and body.

HIPS

Across the fullest part of the seat.

ARM LENGTH

Let hands down the side in a slightly bent position. Measure from center back neck bone, along shoulder point and elbow, to bottom of wrist bone.

GLOVES

Measure palm width.

WHAT CODE REPRESENTS YOUR SIZE?

1. Find your size.
2. The corresponding code is THE CODE you use to complete the part number on your order.
Example: 440227__90
Size: M = Code 06
Therefore 440227 06 90

For tall sizes, look for the "T" next to the size. Example: "MT" stands for Medium Tall.

CODE	00	02	04	72	06	09	73	12	14	16	27	28	29	30	31	32	33
SIZE	OS	XS	S	S/M	M	L	L/XL	XL	2XL	3XL	7	8	9	10	11	12	13
		62		63		64		65		66		67		68			
SIZE		M PLUS		L PLUS		XL PLUS		2XL PLUS		3XL PLUS		4XL PLUS		5XL PLUS			

MEN'S REGULAR · 1.77 M - 1.83 M

JOSH, MEN'S CRUISE AND RUSSELL MESH JACKETS							
	XS	S	M	L	XL	2XL	3XL
Chest (cm)	84-89	89-94	94-102	102-112	112-122	122-132	132-142
Waist (cm)	69-74	74-79	79-86	86-97	97-107	107-117	117-127
Hips (cm)	84-89	89-94	94-102	102-112	112-122	122-132	132-142
Arm length (cm)	76-79	79-81	81-84	84-86	86-89	89	89-91

MEN'S PLUS SIZE · 1.77 M - 1.83 M

BRUCE PLUS, SHAUN PLUS MESH, COOPER PLUS AND MEN'S CRUISE PLUS JACKETS								
	S PLUS	M PLUS	L PLUS	XL PLUS	2XL PLUS	3XL PLUS	4XL PLUS	5XL PLUS
VOYAGER	S	M	L	XL	2XL	3XL		
Chest (cm)	97-102	102-109	109-119	119-130	130-140	140-150	150-157	157-168
Waist (cm)	89-94	94-102	102-112	112-122	122-132	132-142	142-150	150-173
Hips (cm)	98-103	103-110	110-121	121-131	131-141	141-151	151-159	159-182
Arm length (cm)	79	81	84	86	89	89	91	91

LADIES' REGULAR · 1.64 M - 1.77 M

HANNA, LADIES' CRUISE AND KATE MESH JACKETS							
	XS	S	M	L	XL	2XL	3XL
Chest (cm)	81-86	86-91	91-99	99-107	107-114	114-124	124-134
Waist (cm)	61-66	66-71	71-76	76-86	86-94	94-104	104-114
Hips (cm)	86-91	91-97	97-102	102-112	112-119	119-132	132-140
Arm length (cm)	79	79-81	81	81-83	83	83-86	86

LADIES' PLUS SIZE · 1.64 M - 1.77 M

NICKY PLUS, EMMA PLUS MESH, HANNA PLUS AND LADIES' CRUISE PLUS JACKETS						
	M PLUS	L PLUS	XL PLUS	2XL PLUS	3XL PLUS	4XL PLUS
Chest (cm)	99-107	107-114	114-122	122-132	132-142	142-152
Waist (cm)	81-86	86-97	97-104	104-114	114-124	124-135
Hips (cm)	104-109	109-119	119-127	127-137	137-147	147-157
Arm length (cm)	80	81	83	84	86	86

REMOVABLE BACK PROTECTORS

	MEN'S JACKET SIZES	LADIES' JACKET SIZES
S	S and M	XS to L
L	L to 2XL	XL to 5XL
XL	3XL to 5XL	-

MEN'S GLOVES

	S	M	L	XL	2XL	3XL
cm	7.5	8.5	9.5	10.5	11.5	14

LADIES' GLOVES

	XS	S	M	L	XL	2XL
cm	5.7	6.8	7.5	8.3	9	11.5

HELMETS

	XS	S	M	L	XL	2XL	3XL
Head circumference (cm)	53-54	55-56	57-58	59-60	61-62	63-64	65-66

CAN-AM SPYDER RT RIDING BOOTS

SIZE US/CA	7	8	9	10	11	12	13
SIZE EU	40	41	42	43	44	45	46
Foot length (in)	10.0	10.2	10.5	10.7	11.0	11.3	11.5
Foot length (cm)	25.3	26.0	26.7	27.3	28.0	28.7	29.3

ACCESSORIES



**LOOK BEYOND
THE ORDINARY.**



UNIQUE BEGINS WITH U

Create a Can-Am Spyder that's as unique as you are.
Our exclusive 4U Guide is the key to kick starting your customization.
Choose and cruise. As easy as 1-2-3-4.

We created the 4U Guide, your personal guide to customization. It's based on you - your needs, your riding style, your personality and preferences - so the accessories you choose will be the right ones.

These 4 questions will help you better understand your needs and really make this guide work for you in selecting accessories.

1. Is your Can-Am Spyder adjusted to your body?

Run through our U-Fit section and find what handlebar and footpeg positions fit you best.

2. Does your Can-Am Spyder have all the accessories you need?

Would you like to reduce the wind flow to your face? Are you riding solo or 2-up? Do you need more storage space? Check out our U-Function section and make your vehicle better suited for you.

3. Does your Can-Am Spyder truly express your personality?

Are you looking for a sportier attitude? Or a more luxurious look with chrome accessories? Discover our custom accessories in the U-Style section.

4. Do you want to unleash the power and handling of your Can-Am Spyder?

Are you looking for a deeper more guttural sound? A cushier ride? Find what you need in our U-Performance section.

The 4U Guide is the simplest way to create a Can-Am Spyder that's truly a reflection of you. We've thought of everything including compatibility and fit with accessories. The 4U Guide makes choosing accessories simpler, more practical, and easier to understand. Now nothing stops U.



U-FIT

Now you can tailor your Can-Am Spyder to fit you like a dream. Tweak and adjust the fit that lets you truly connect with your ride. It's all about comfort and enjoying every stretch and curve of the road to freedom.

UFIT SYSTEM
HANDLEBARS
BRAKE & SHIFTER LINKAGES
FOOTBOARDS



U-FUNCTION

Every outing is different and that's part of the fun. Customize your Can-Am Spyder for the way you usually ride, and thanks to our easy-to-add or -remove integrated accessories, you can adjust as you need. Is it a solo or 2-up trip today? Stripped down or fully loaded? It's your journey—do it your way.

SEATS & BACKRESTS
WINDSHIELDS & WIND PROTECTION
CARGO & STORAGE
LIGHTS & ELECTRICAL ACCESSORIES



U-STYLE

Personalization speaks volumes about who you are, and our custom accessories let you say it with added sophistication and style. Don't just embrace your inner self, make a statement.

WHEELS
FENDERS
CUSTOM ACCESSORIES
DECALS



U-PERFORMANCE

Unleash the untapped power and handling of your Can-Am Spyder with our performance-boosting accessories. Because freedom means you get to choose how you travel your road.

SHOCKS
SILENCERS



SPYDER F3

ACCESSORIES

BLUE RIDGE WINDSHIELD 219400746



SIGNATURE LIGHT 219400599

Let our customized versions of these Can-Am Spyder F3 serve as inspiration for creating your own! How would you build yours?

F3-S SPEEDWAY INSPIRED LOOK

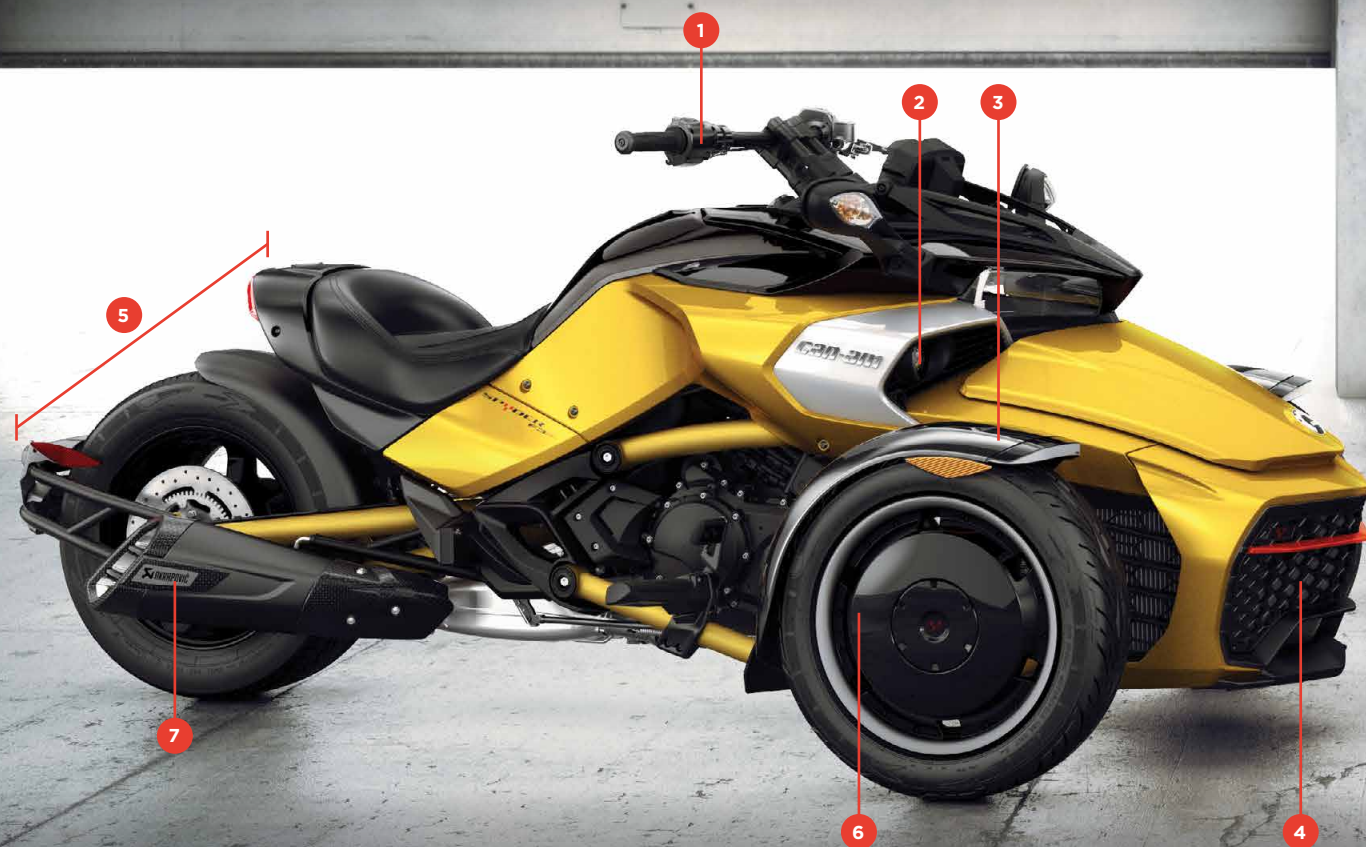

F3-S BREAK FREE INSPIRED LOOK



U-FIT

- 1 DRAG BAR P. 51

U-FUNCTION

- 2 AUXILIARY LIGHTS P. 63

U-STYLE

- 3 LOW BROW FRONT FENDERS P. 66
- 4 SUPER SPORT GRILLE P. 67
- 5 BOBBER KIT P. 67
- 6 15" BONNEVILLE DISH WHEELS P. 65

U-PERFORMANCE

- 7 AKRAPOVIČ[®] SINISTER SILENCER P. 71
- 8 FOX[®] ADJUSTABLE REAR SHOCK (NOT VISIBLE ON THE IMAGE ABOVE) P. 69
- 9 FOX FACTORY SERIES 1.5 PODIUM R FRONT SHOCKS (NOT VISIBLE ON THE IMAGE ABOVE) P. 70

U-FIT

- 1 DRIVER FOOTBOARDS P. 53
- 2 PASSENGER FOOTBOARDS P. 53

U-FUNCTION

- 3 BLUE RIDGE WINDSHIELD P. 56
- 4 AUXILIARY LIGHTS P. 63
- 5 ROADTHUNDER[®] SOUNDBAR BY MTX[®] P. 64
- 6 VINYL COAST-TO-COAST SEAT P. 54
- 7 DETACHABLE DRIVER BACKREST P. 55
- 8 DETACHABLE PASSENGER BACKREST P. 55
- 9 SHAD SADDLEBAGS FOR CAN-AM P. 59

U-STYLE

- 10 RT-S FRONT WHEELS P. 85

U-PERFORMANCE

- 11 OCCASIONAL 2-UP REAR SHOCK (NOT VISIBLE ON THE IMAGE ABOVE) P. 70

Looking to personalize your Spyder F3 Limited?
Here is one of countless possibilities.

F3 LIMITED WEEKEND ESCAPE INSPIRED LOOK

CHROME EDITION



F3-T URBAN CRUISER INSPIRED LOOK

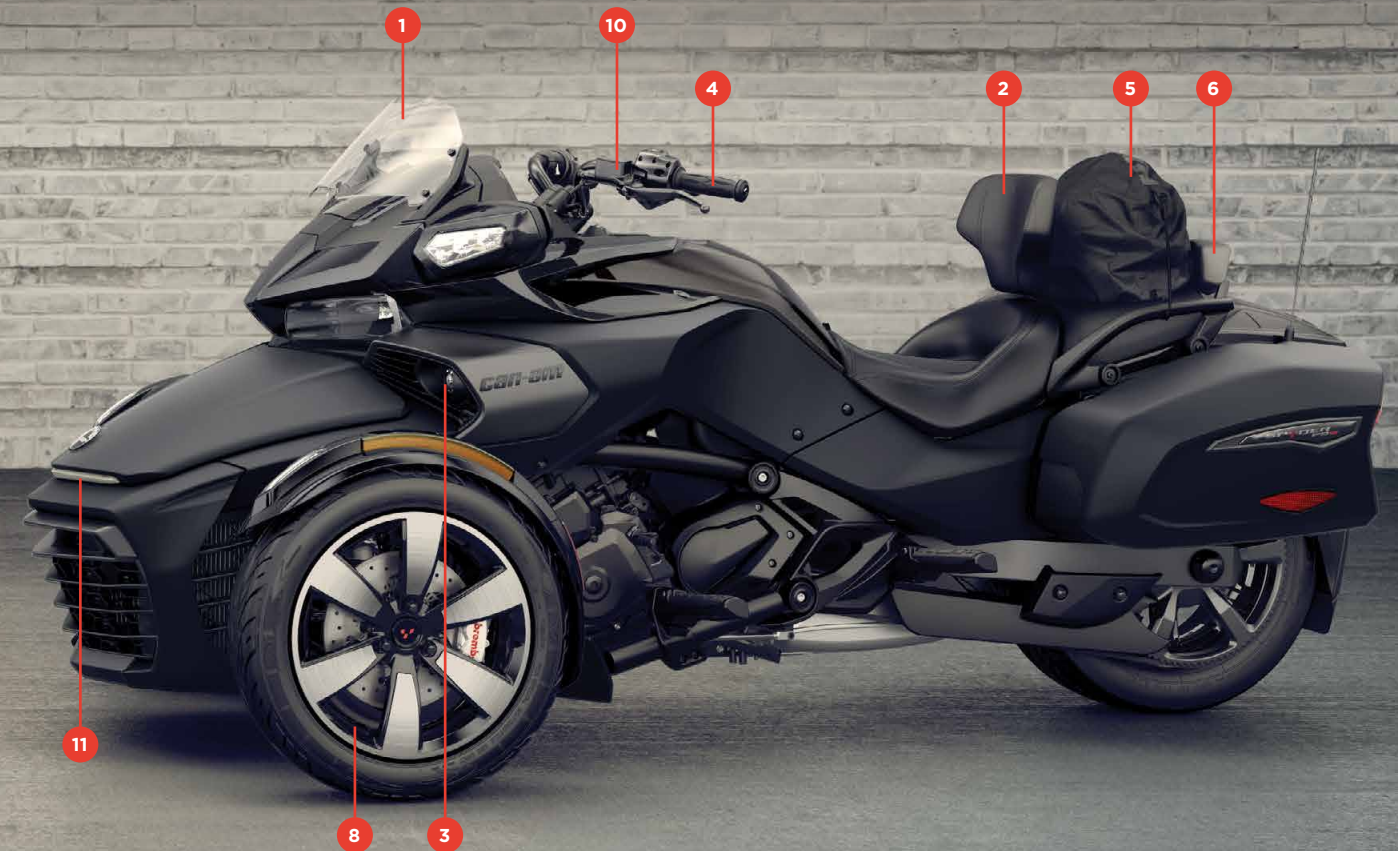

U-FUNCTION

1 AUXILIARY LIGHTS	P. 63	7 DELUXE SADDLEBAGS LINERS (NOT VISIBLE ON THE IMAGE ABOVE)	P. 60
2 TALL BOY WINDSHIELD	P. 57	8 TOP CASE INNER BAG (NOT VISIBLE ON THE IMAGE ABOVE)	P. 61
3 AKRAPOVIČ SPORT TOURING 3C SILENCER	P. 71		
4 PASSENGER ARMRESTS	P. 55		
5 TOP CASE RACK	P. 61		
6 DETACHABLE DRIVER BACKREST	P. 55		

U-FUNCTION

1 LOW BOY WINDSHIELD	P. 57	7 AUTOMATIC REAR AIR SUSPENSION KIT (NOT VISIBLE ON THE IMAGE ABOVE)	P. 70
2 DETACHABLE DRIVER BACKREST	P. 55	8 DELUXE SADDLEBAGS LINERS (NOT VISIBLE ON THE IMAGE ABOVE)	P. 60
3 AUXILIARY LIGHTS	P. 63	9 FRONT CARGO BAG (NOT VISIBLE ON THE IMAGE ABOVE)	P. 60
4 HEATED DRIVER GRIPS	P. 63		
5 INTEGRATED HELMET BAG	P. 62		
6 PASSENGER SHORT RAIL	P. 55		

U-FIT

10 ATTITUDE HANDLEBAR	P. 51
-----------------------	-------

U-STYLE

11 SIGNATURE LIGHT	P. 68
--------------------	-------

U-PERFORMANCE

12 FOX ADJUSTABLE FRONT SHOCKS (NOT VISIBLE ON THE IMAGE ABOVE)	P. 69
--	-------



YOUR CAN-AM SPYDER. YOUR FIT.

All Spyder F3 models feature our exclusive UFit system so you can customize an exact fit based on your height or preferred riding style. Choose from five footpeg positions and five handlebar options to optimize your fit and comfort.

Find your perfect Spyder fit at [UFITSYSTEM.COM](https://ufitsystem.com) or visit your dealer to test drive and ask about the showroom fit tool.

CHOOSE FROM 5 HANDLEBAR OPTIONS

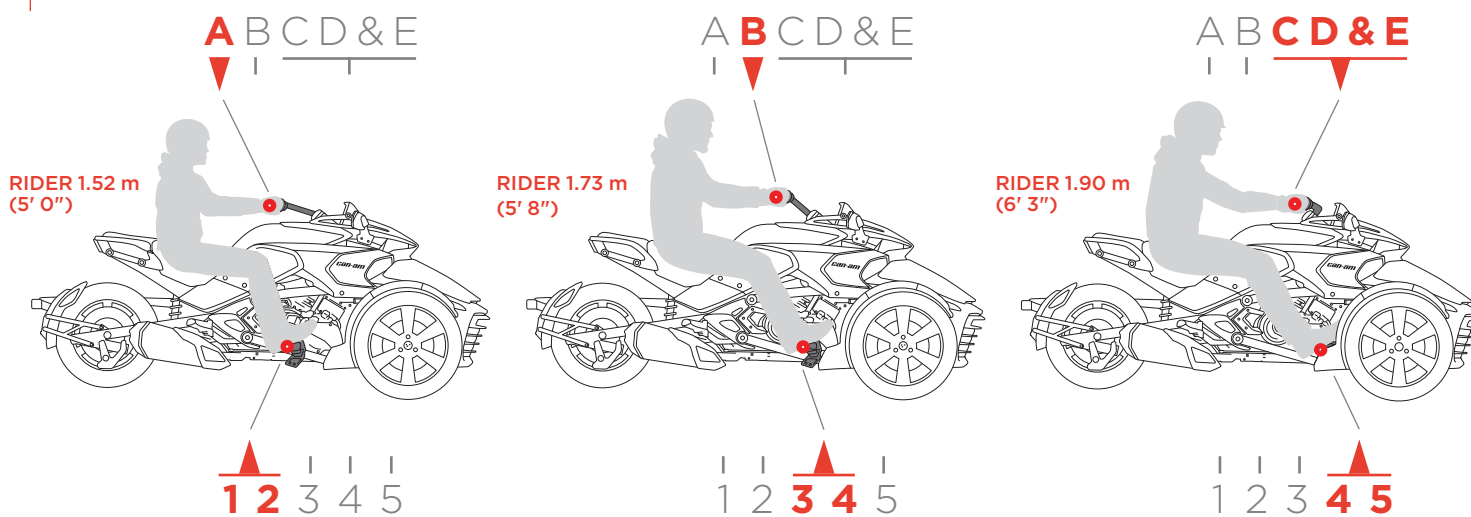

CHOOSE FROM 5 FOOTPEG POSITIONS

Some products may not be available or homologated in your region. Contact your dealer for more information.



HANDLEBARS UFIT SYSTEM

SHORT REACH HANDLEBAR · POSITION A

- Part of the UFit System.
- Perfect for shorter riders with pegs positions 1 or 2.

All Spyder F3 models

■ 219400545 · Chrome
(Clamp Kit included)

■ 219400546 · Carbon Black



STOCK HANDLEBAR · POSITION B

- Part of the UFit System.
- Same shape and reach as the stock handlebar with a chrome finish.
- Fits best with pegs positions 3 or 4.

All Spyder F3 models

■ 219400547 · Chrome
(Clamp Kit included)



LONG REACH HANDLEBAR · POSITION C

- Part of the UFit System.
- The longer reach causes the torso to lean forward, bringing the riding position closer to the console.
- Perfect for taller riders with pegs positions 4 or 5.

All Spyder F3 models

■ 219400548 · Chrome
(Clamp Kit included)

■ 219400549 · Carbon Black



ATTITUDE HANDLEBAR · POSITION D

- Part of the UFit System.
- The shape has an impact on the driving position, leaning the torso towards the console and tilting the arm and wrist position.
- Perfect for taller riders with pegs positions 4 or 5.

All Spyder F3 models

■ 219400550 · Chrome
(Clamp Kit included)

■ 219400551 · Carbon Black



DRAG BAR · POSITION E

- Part of the UFit System.
- Race-inspired straight bar is wide and more forward for a more aggressive riding position or tall drivers.
- Perfect for taller riders with pegs position 5.

All Spyder F3 models

■ 219400646 · Chrome
(Clamp Kit included)

■ 219400594 · Carbon Black





BRAKE & SHIFTER LINKAGES



BRAKE & SHIFTER LINKAGES

- Part of the UFit System.
- Find the best driving position for you.
- Replace stock linkage to set pegs to different positions.

All F3 SE6 models

- 2 · Position 1 · 219400561
- 1 · Position 2 · 219400563
- +1 · Position 4 · 219400566
- +2 · Position 5 · 219400571

All F3 SM6 models

- 2 · Position 1 · 219400560
- 1 · Position 2 · 219400562
- +1 · Position 4 · 219400564
- +2 · Position 5 · 219400565



FOOTBOARDS



DRIVER FOOTBOARDS

- Replace stock pegs for additional comfort.
- Come with rubber pads and mounting hardware.
- Can be positioned with the UFit System.

All Spyder F3 models

- 219400572 - Chrome
- 219400529 - Carbon Black



PASSENGER FOOTBOARDS

- Replace stock pegs for additional comfort.
- Come with rubber pads and mounting hardware.

All Spyder F3 models

- 219400716 - Chrome
- 219400715 - Carbon Black

IDLER PULLEY

F3 IDLER PULLEY SERVICE KIT

(Not illustrated)

- Enhances your comfort on the road by reducing vibrations generated by the belt.

All Spyder F3 models

219800431



U-FUNCTION

SEATS & BACKRESTS



LEATHER COAST-TO-COAST SEAT

- Genuine stitched-leather* seat.
- Passenger and driver seats rain cover included.
- Installs in seconds and works with both driver and passenger backrests.
- Long-distance comfort based on our renowned coast-to-coast seat design.
- Wide, well-shaped and generously padded driver and passenger seats deliver enough comfort for a coast-to-coast ride.

* Natural leather fades and wrinkles over time. Allow to air-dry when wet, apply leather-conditioning oil to maintain appearance. Clean with warm water, mild soap and a soft cloth. Use the included seat cover to keep your seat looking new longer.

All Spyder F3 models

■ 219400656 - Tan



VINYL COAST-TO-COAST SEAT

- Long-distance comfort based on our renowned coast-to-coast design.
- Wide, well-shaped and generously padded driver and passenger seats deliver enough comfort for a coast-to-coast ride.
- Installs in seconds and works with both driver and passenger backrests.

All Spyder F3 models

■ 219400602 - Black



PASSENGER ARMRESTS

- Adjust upwards, downwards, forwards, backwards, and outwards.
- Arm height provides up to 20 mm vertical adjustment.
- Fully-compatible with RAM® cup holder.
- Complete with grip for added passenger security.
- Top Case not required for installation or use.
- Recommended to install with Top Case (219400732) or Passenger Backrest (219400601 or 219400703).

All Spyder F3 models

■ 219400726 - Black



ADJUSTABLE PASSENGER BACKREST

- Dual axis adjustments for the backrest and cushion enable you to dial-in comfort and add up to 50 mm more passenger room.

Spyder F3, F3-S, F3-T

■ 219400601 - Carbon Black



DETACHABLE DRIVER BACKREST

- Generous width and height for superior lumbar support.
- Installs and removes in minutes.
- Tilt adjustable.
- Fits on production, Cannonball, Vinyl Coast-to-Coast and Leather Coast-to-Coast seats.
- Anti-theft feature.

All Spyder F3 models

■ 219400498 - Black



CANNONBALL SEAT

- 2-piece driver and passenger seats.
- Installs in minutes.
- Designed with additional padding, larger support areas and integrated comfort rear pad.
- Distinctive high-end stitching pattern.
- Driver backrest ready.

All Spyder F3 models

■ 219400497 - Black



DETACHABLE PASSENGER BACKREST

- Generous width and height for superior lumbar support.
- Initial installation in minutes, toolless removal in seconds.
- Anti-theft feature.
- Fits on production, Cannonball, Vinyl Coast-to-Coast and Leather Coast-to-Coast seats.
- Invisible mounting system unrecognizable when not installed.

Spyder F3, F3-S, F3-T

■ 219400703 - Black



PASSENGER SHORT RAIL

- Sporty looking short passenger comfort rear pad.
- Installs in minutes.
- Fits on production, Vinyl Coast-to-Coast and Leather Coast-to-Coast seats.

Spyder F3, F3-S, F3-T

■ 219400580 - Black



Can-Am Spyder accessories are subject to the same rigorous physical testing requirements as the vehicles.



WINDSHIELDS & WIND PROTECTION



BLUE RIDGE WINDSHIELD

- Made of clear 4.5 mm polycarbonate.
- Comes complete with supports and hardware.

Spyder F3, F3-S

219400746 · Clear

ROUTE 129 WINDSHIELD

- Sport windshield.
- Made of 4.5 mm polycarbonate.
- Provides lower body protection.
- Comes complete with supports and hardware.

Spyder F3, F3-S

219400747 · Clear

TALL BOY WINDSHIELD

- Mid-height windshield.
- Scratch and UV-resistant hardcoat on 5 mm polycarbonate shield.
- Windshield supports included.

Spyder F3-T, F3 Limited

219400596 · Clear

LOW BOY WINDSHIELD

- Sporty low windshield.
- Scratch and UV-resistant 4.5 mm polycarbonate shield mounts on the stock supports.

Spyder F3-T, F3 Limited

219400504 · Smoke



CARGO & STORAGE



SHAD SADDLEBAGS FOR CAN-AM

- Patented lightweight bike-specific design.
- 3-point mount.
- Waterproof, shock resistant.
- 36 liters capacity (9.5 US gallons).
- Enough room for a 2XL full face helmet equipped with a communication system.
- Unique Can-Am reflector.
- Required mounting support and hardware are sold separately (219400728).
- Required mounting support for Europe (219400727).

Spyder F3, F3-S

■ 219400721 - Black

SHAD SADDLEBAGS F3 RACK

(Not illustrated)

- Custom rack specially designed for mounting SHAD Saddlebags (219400721).
- Integrated red reflectors and necessary hardware for SHAD Saddlebags.

Spyder F3, F3-S

■ 219400728 - Black

■ 219400727 - Black - Europe (Amber reflectors) EC compliant

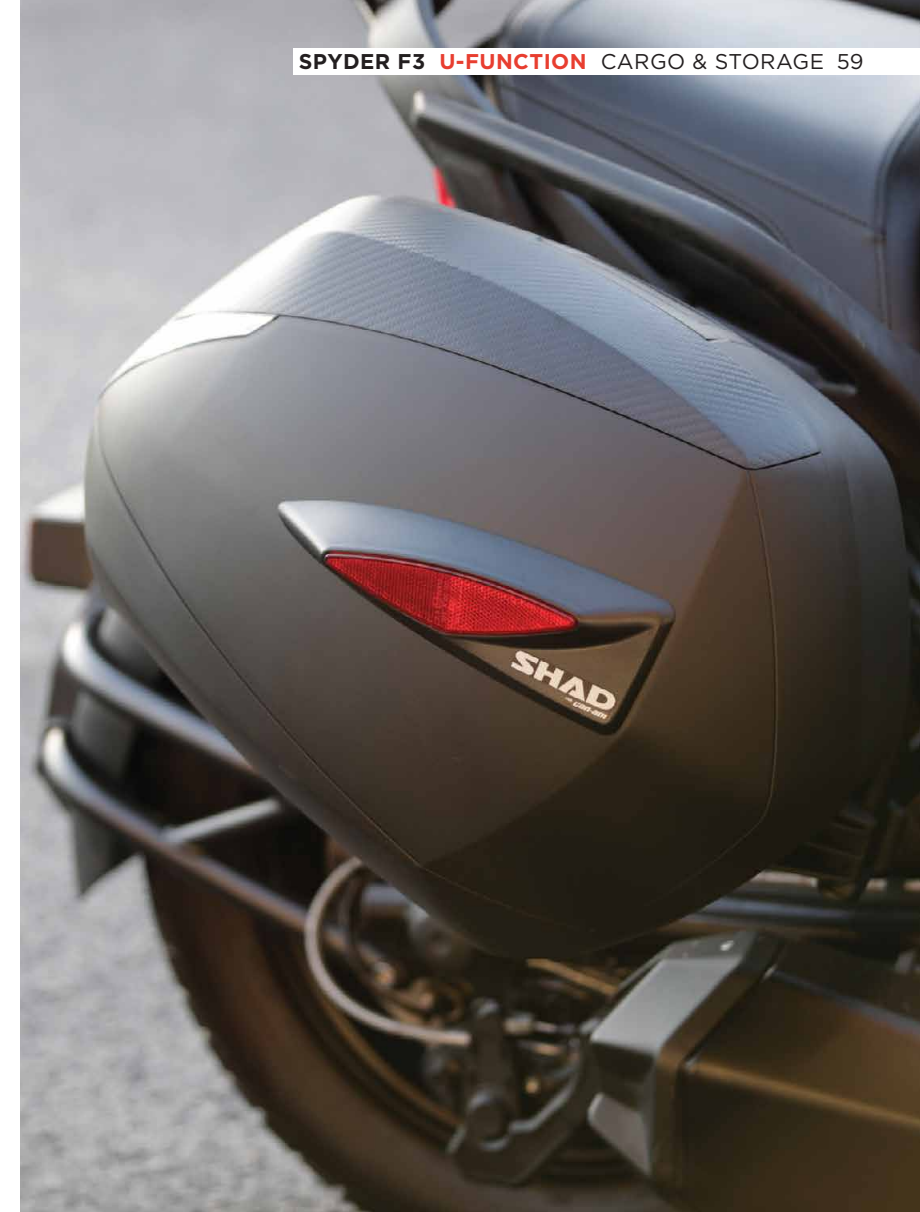

SHAD SADDLEBAGS LINERS

- Designed expressly for SHAD Saddlebags (219400721) to provide extra convenience.
- Include integrated carrying handle and a shoulder strap.
- Sold in pairs.

Spyder F3, F3-S

■ 219400731 - Black



SHAD REAR SEAT BAG

- 100% waterproof 3-layer (PVC-Nylon-PVC) design that's tear and abrasion resistant.
- 28 liters capacity (7.4 US gallons).
- Foam-lined inner compartment for laptop or other valuables.
- Includes attachment straps.
- Converts to backpack, complete with chest strap.

All Spyder models

■ 219400730 - Black



SHAD BACKPACK E-83

- Semi-rigid exterior.
- Secure storage in 2 zippered main compartments.
- Zippered inner pocket with padded compartments.
- Adjustable waist and chest straps.
- Cushioned carry handle.
- Includes cover for any helmet size that can be fixed to the backpack with 4 metal buckles.

■ 219400729 - Black

SHAD

FOR can-am

BRP partners with SHAD, a recognized leader in the manufacture of high-advanced motorsport bags and storage accessories.

Their designs are known to be the state-of-the-art, totally functional and of first class quality, which have earned them the prestigious international "Red Dot: Best of the Best" award in 2015.



CROSS-COUNTRY DETACHABLE SADDLEBAGS

- Add a total of 50 liters (13 US gallons) of storage space.
- Finished in high-end vinyl and with a metal chrome side hinge.
- Water-resistant and top loading, lockable with key.
- Toolless installation and removable in seconds after initial installation.
- Brackets are invisible when bags are not on.
- Bolts 250000869 needed to install 2015 Cross-Country Detachable Saddlebags (219400492 and 219400590 (EC)) on 2016 models.

Spyder F3, F3-S

- 219400696 - Black
- 219400697 - Black · Europe (Amber light) · EC compliant



DELUXE SADDLEBAGS LINERS

- Complete your production saddlebags with Deluxe Saddlebags liners.
- The easiest way to carry your items from your Can-Am Spyder saddlebags, with integrated handle.

Spyder F3-T, F3 Limited

- 219400606 - Black



CROSS-COUNTRY SADDLEBAGS LINERS

- Soft travel bags for use inside the Cross-Country Detachable Saddlebags (219400696, 219400697 EC).
- Integrated handle for easy transport.
- Sold in pairs.

Spyder F3, F3-S

- 219400609 - Black



FRONT CARGO BAG

- Easy way to organize and tote your items in the front cargo compartment.
- Slides in and out with integrated handle and shoulder strap.

All Spyder F3 models

- 219400631 - Black

LOCK KIT FOR CROSS-COUNTRY DETACHABLE SADDLEBAGS

- (Not illustrated)
- Replacement lock and key for Cross-Country Detachable Saddlebags (219400696, 219400697 EC)

Spyder F3, F3-S (service kit)

- 219400737



TOP CASE WITH INTEGRATED PASSENGER BACKREST

- Fits up to two 2XL full face helmets including communication system.
- Integrated passenger backrest.
- Protective rubber carpet-lined bottom.
- Quick installation and removal.
- Required vehicle color matching side panels to complete the top case assembly - sold separately.

Spyder F3-T 2018 and prior

- 219400897 - Black
- 219400898 - Black · Europe · EC certified

- Top Case Speakers Amplifier Kit (219400769) is required to play music through top case speakers for Spyder F3-T 2016-2017 & F3 Limited 2016.



TOP CASE PANEL KIT

- Vehicle-matched top case side panels.

Spyder F3-T with Top Case

- 219400758 - Steel Black Metallic
- 219400759 - Pearl White
- 219400760 - Intense Pearl Red
- 219400761 - Pure Magnesium
- 219400859 - Oxford Blue Metallic



TOP CASE INNER BAG

- Maximizes top case volume.
- Complete with integrated handle and shoulder strap for convenient portability.

Spyder F3-T with Top Case, F3 Limited 2017 & up

- 219400748 - Black



TOP CASE SPEAKERS AMPLIFIER KIT

(Not illustrated)

- Amplifier kit is required* to play music through top case speakers.
- Connects to the standard front audio system.
- Includes amp harness and hardware.
- Top Case with Integrated Passenger Backrest (219400732, 219400772 EC) is required.

Spyder F3-T 2016-2017 with Top Case

- 219400769



TOP CASE RACK

- Allows for added external storage capacity when used with netting or bungee cords.
- Sturdy stamped-aluminum construction.
- Includes integrated anchor points.

Spyder F3-T with Top Case, F3 Limited 2017 & up

- 219400743 - Black



REAR TAIL RACK

- Robust monobloc cast-aluminum construction.
- Ideal for stowing soft bags, tents, or sleeping bags.
- Includes convenient integrated anchor points.
- Bolts securely to the vehicle frame.

Spyder F3-T, F3 Limited 2016

■ 219400645 · Black



F3 MONO SEAT COWL

- High quality injection-molded part.
- Pops into passenger seat space in seconds.
- Transforms your vehicle into sporty solo configuration.
- Adds 4.73 liters (1.25 US gallon) of lockable water-resistant storage.

Spyder F3, F3-S

■ 219400494 · Steel Black Metallic



LIGHTS & ELECTRICAL ACCESSORIES



NEW INTEGRATED HELMET BAG

- Truly integrated easy-to-use helmet storage solution.
- Sturdy water-resistant construction.
- Includes elastic straps for tying down helmet bag onto seat.
- Complete with anti-theft wire for added security.

All Spyder RT & F3 models

■ 219400850 · Black



URBAN RACK

- Solid aluminum construction offering 3.37 liters (0.9 US gallon) of water-resistant storage.
- Comes with net to allow users to strap additional luggage on top.
- Pops into passenger seat space in seconds.
- Anti-theft feature.

Spyder F3, F3-S

■ 219400493 · Carbon Black



AUXILIARY LIGHTS

- Halogen fog lamps.
- Enhance low beam light for better visibility.
- Plug-and-play with stock harness.

All Spyder F3 models

219400511

- Integrated ON/OFF switch.
- Not EC compliant.
- Not compatible with European vehicles.



HEATED DRIVER GRIPS

- Complete heating kit with one intensity setting.
- Easy installation.
- Integrated ON/OFF switch.

Spyder F3, F3-S, F3-T

■ 219400509 · Black

NEW ROADTHUNDER SOUNDBAR BY MTX

- Bluetooth speaker with the unbeatable convenience of fingertip control.
 - Rugged IP66-rated weather-resistant speaker designed for outdoor use.
 - Driven by 150 watts of quality audio power.
 - Seamless integration and operation from Bluetooth enabled devices.
 - Includes: input, ground and ignition wires, plus auxiliary port and 3.5" connector cable.
- Note: We recommend you to use 320 Kbps MP3 - 192-256 Kbps AAC or AIFF, WAV formats to match the potential of the speaker. More compressed formats will probably have degraded sound quality.

Spyder F3, F3-S
219400840



NEW CGX3 CAMERA

- 160° wide angle lens.
- Resolution options: from 3MP up to 20MP and VGA.
- Video resolutions available: 2.7K at 30 frames per second (FPS), 720P at 120/60/30 FPS, 1080P at 60/30 FPS and VGA at 240 FPS.
- Record videos in 4K UHD at 24 FPS, 2.7K QHD at 30 FPS and 720P at 120 FPS.
- Memory: Class 10 32GB micro SD card.
- 2" capacitive touchscreen.
- Li-ion battery capacity of 1050mAh, working time of 1/1.5 hours and charging time of 3 hours (2 batteries included).
- WiFi function remotely operates up to 15 meters (49.2') with mobile devices and CYCLOPS app for Android and IOS.
- Waterproof up to 10 meters (32.8') without a case.
- Features modes such as invert, time lapse, high speed & loop recording, motion detection, capture (while recording a video), burst and anti-sharing.
- Comes with 8 mounting accessories.



9700130090

CYCLOPS 360° PANORAMIC HD VIDEO CAMERA

- Features a 220-degree wide-angle lens.
- Video resolutions up to 4K at 30 frames per second.
- Professional 16MP quality photos.
- Rugged, light and portable.
- Magnetic mount for vibration-free footage and mounting to any metal surface.
- Comes with 32GB Class 10 micro SD card.
- Waterproof case up to 50 meters (164').
- Wi-Fi available to remotely control your camera from your smartphone or computer with the free CGX2 App.
- 16 modes and effects, including driving mode, loop recording, time lapse and slow motion.
- Comes with 10 mounting accessories.
- Compatible with VR goggles.



9700020090

GPS HOLDER (WITHOUT HARNESS)

(Not illustrated)
All Spyder F3 models
219400717

GARMIN ZUMO GPS HOLDER (WITHOUT HARNESS)

(Not illustrated)
All Spyder F3 models
219400718

BOLTS KIT FOR GPS HOLDER

(Not illustrated)
· Required to fit Garmin Zumo GPS Holder (219400718) on Drag Bars (219400646, 219400594).
All Spyder F3 models
219400655

GPS HOLDER

· Sits high on right side handlebar for optimum visibility.
· Multidirectional adjustment to prevent sun glare and adapts to any rider.
· Harness included.
All Spyder F3 models
219400749



GARMIN ZUMO 590 GPS

- Features a glove-friendly and sunlight-readable 12.7 cm (5") dual-orientation touchscreen display.
- Offers hands-free phone control and spoken directions heard in-helmet via Bluetooth® 5 technology.
- Includes a MP3 player.
- iPod® and Pandora® compatibility.
- Allows control of music right on the display.
- Rugged and tough enough to withstand fuel spills, UV rays and harsh weather.
- Offers access to real-time weather and traffic information via the smartphone link app.
- Free lifetime map updates.
- Curvy Roads Routing allows rider to find winding roads.
- GPS Holder (219400681) sold separately.



Zumo 590 has the ability to link itself wirelessly to optional Garmin tire pressure sensors and the Garmin Virb video camera for enhanced GPS functionality.

All Spyder models

219400512
219400699 - Europe

POWER OUTLET KIT

- Recharges your electronic devices while riding* (smartphone, MP3, heating gear, etc.).
 - Dual port USB connectors.
 - Plug-and-play kit.
 - Simply connect under driver seat and use.
- *The power outlet is not capable of recharging all device types while riding.



All Spyder RT models, RS, ST, F3, F3-S

219400510 - USB
· Adds an extra 12V power outlet to your vehicle.
· Conveniently located in front cargo bin.

All Spyder models

219400366 - 12V

GARMIN ZUMO GPS HOLDER

- Positions Garmin Zumo GPS on the center of all UFit System handlebars.
- Wiring/charging harness included.



All Spyder F3 models

219400681

F3-T FRONT RADIO SYSTEM

- Upgrades sound, 2 woofers speakers and 2 mids (4X20 watts), USB plugs, aerial and hardware included.



Spyder F3-T, F3 Limited 2016

219400680

U-STYLE

WHEELS

15" SHAMROCK WHEELS

- Add personality to your Can-Am Spyder.
- Casted, painted and machined wheels.
- Sold in pairs.

All Spyder F3 and RT models, RS, ST 2013 and up

■ 219400500 - Deep Black



15" FAT 6 CHROME WHEELS

- Same design as Spyder F3 production wheels in PVD finish.
- Sold in pairs.

All Spyder F3 and RT models, RS, ST 2013 and up

■ 219400589 - Chrome



CHROME REAR WHEEL

- 6-spoke PVD – chrome-like powder-coat, more resistant than regular chrome – monobloc rear wheel (hub and wheel in one piece).

All Spyder F3 and RT models, RS, ST 2013 and up

■ 219400574 - Chrome



15" BONNEVILLE DISH WHEELS

- Give your Can-Am Spyder a retro look with these 15" wheels inspired by Salt Flat racers.
- Wheel nuts are hidden behind the center cap.
- Sold in pairs.

All Spyder F3 and RT models, RS, ST 2013 and up

■ 219400501 - Black



15" BLADE MAG WHEELS

- Unidirectional design (left and right wheel).
- Patented casting process allows a weight reduction of 1 kg (2.2 lbs) per wheel compared to stock wheels.
- Sold in pairs.

All Spyder F3 and RT models, RS, ST 2013 and up

■ 219400465 - Black



15" BLADE MAG WHEELS SERVICE KIT

- (Not illustrated)
- Replacement "blade" for wheels.
- 219400542 - Left - Brushed Aluminum
- 219400543 - Right - Brushed Aluminum

15" RT FRONT WHEELS

- 15" 12-spoke mags.
- Sold in pairs.

All Spyder F3 and RT models, RS, ST 2013 and up

■ 219400365 - Grey

■ 219400419 - Carbon Black





CUSTOM ACCESSORIES



A bobber, originally called a 'bob-job' from the 1930s through 1990s, is a style of custom motorcycle. The typical construction includes stripping excess bodywork from a motorcycle, and shortening the rear fender, which is "bobbed" (as in bob-tail).



BOBBER KIT*

- Everything needed to transform a 2-up into a 1-up.
- Rear fender, tail light assembly, footrest trim, license plate support, and all necessary hardware included.
- Can also accommodate any production or accessory seat.

* · A bobbed tail increases the amount of projection from the rear tire versus a traditional fender.

· Laws vary state to state regarding rear fender tire coverage compliance. Please obey all applicable laws and regulations.

Spyder F3, F3-S

- 219400640 - Black
 - 219400745 - Black - Europe - EC compliant
- (Doesn't include rear fender and licence plate support)

SUPER SPORT GRILLE

- Adds an even more muscular look with this honeycomb-styled front grille with integrated front splitter.

All Spyder F3 models

- 219400595 - Black / Can-Am Red

FENDERS

CHOPPED REAR FENDER

- Sleek, short fender shows off the massive Spyder F3 rear tire.
- Street legal and includes license plate holder, LED light and required hardware.
- License plate holder not compliant outside North America.

Spyder F3, F3-S

- 219400597 - Carbon Black



LOW BROW FRONT FENDERS

- Super sleek drawn steel fenders with LED position lights integrated into the front edge.
- Include electrical harness and required hardware.
- Sold in pairs.
- LED position lights not EC compliant.

All Spyder RT models, RS, ST 2013 and up, all Spyder F3 models

- 219400502 - Carbon Black



PULLEY COVER

- Replaces the stock plastic PTO (drive pulley) cover with a genuine chrome cover.

All Spyder F3 models

- 219400557 - Chrome



TMC COVER

- Replaces the stock plastic TMC (master cylinder) cover with a genuine chrome cover.

All Spyder F3 models

- 219400559 - Chrome



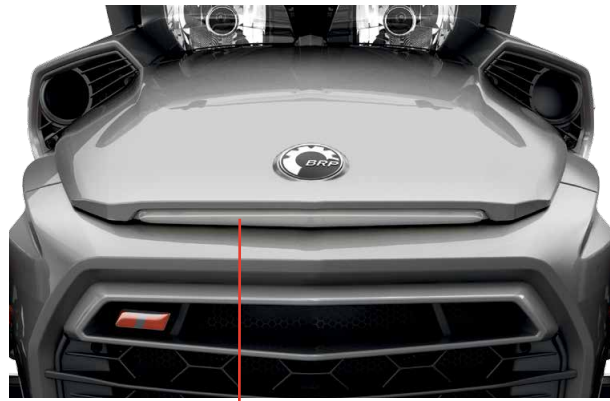

SIGNATURE LIGHT

- Creates an unmistakable, distinctive look.
- No switch, automatically turns on.
- Includes required wiring and hardware for Spyder F3 2016 models and up.
- Not EC compliant.

All Spyder F3 models

- 219400599 - White

SIGNATURE LIGHT - 2015 ADAPTER KIT

- (Not illustrated)
- Wiring harness required for installing Signature Light (219400599) on 2015 models.
 - Allows the light to automatically illuminate when the engine is running.
 - LED lights.

Spyder F3, F3-S 2015

- 219400636 - Black



HANDLEBAR END CAPS

- Sold in pairs.

All Spyder models

- 219400702 - Chrome



FRAME CAPS

- Add a little bling to the frame of your vehicle.
- 4 frame caps per pack.

All Spyder F3 models

- 219400555 - Chrome



DECALS



HOOD STRIPES DECAL KIT

- Adds personality to your Can-Am Spyder F3.

All Spyder F3 models

- 219400711 - Can-Am Red
- 219400714 - Gloss White
- 219400713 - Matte Black
- 219400712 - Satin Silver



F3 MONO SEAT COWL STRIPES DECAL KIT

- Premium decals complement Hood Stripes Decal Kit.

Spyder F3, F3-S

- 219400661 - Can-Am Red
- 219400662 - Gloss White
- 219400663 - Matte Black
- 219400664 - Satin Silver



REAR TAIL STRIPES DECAL KIT

- Premium decals complement Hood Stripes Decal Kit.

Spyder F3-T, F3 Limited 2016

- 219400665 - Can-Am Red
- 219400666 - Gloss White
- 219400667 - Matte Black
- 219400668 - Satin Silver



U-PERFORMANCE

SHOCKS



FOX ADJUSTABLE FRONT SHOCKS

- Features spring-adjustable preload and wide-range externally-adjustable rebound damping for an infinite array of tuning options made to suit any riding style.
- Whether it's smooth cruising or twisting down your favorite winding road they deliver exceptional performance, comfort, and a superior quality ride.

Spyder F3-T, F3 Limited

- 219400733



FOX ADJUSTABLE REAR SHOCK

- FOX Factory Series rear shock delivers an infinite range of set-up options.
- Anodized lightweight 6061-T6 aluminum body provides enhanced reliability and excellent performance.

Spyder F3, F3-S

- 219400734



FOX shocks have been an industry leader in high-performance shocks and racing suspensions for over 30 years.

FOX FACTORY SERIES 1.5 PODIUM R FRONT SHOCKS

- Featuring spring-adjustable preload and a wide range of externally adjustable rebound damping, the PODIUM R shocks provide an infinite array of tuning options to comfortably suit your riding style.
- Whether you're out for a mellow cruise or enjoying your favorite twisty route, the PODIUM R shocks will deliver superb performance, great comfort, and an overall quality ride.

Spyder F3, F3-S
219400515



FOX FACTORY SERIES 2.0 PODIUM RC2 REAR SHOCK

- Provides an infinite range of options for the perfect set-up.
- Its anodized 6061-T6 aluminum body and remote aluminum reservoir make the lightweight PODIUM RC2 shock a reliable and awesome performer.

Spyder F3, F3-S
219400577

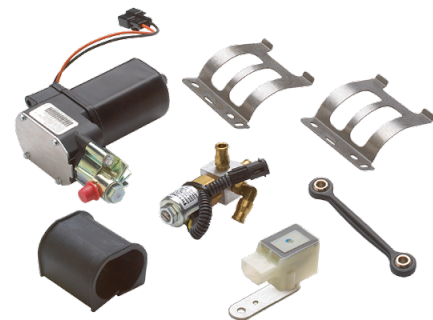

AUTOMATIC REAR AIR SUSPENSION KIT

- Automatic suspension assures a smooth, comfortable ride.
- Includes air compressor and all required hardware.

Spyder F3-T, F3 Limited
219400738



OCCASIONAL 2-UP REAR SHOCK

- Weight-bearing capacity designed for occasional 2-up use.

Spyder F3, F3-S
219400739



SILENCERS



Akrapovič was established in 1990 by Slovenian racer Igor Akrapovič who had found that during his racing career there was a distinct lack of high-quality exhaust systems on the market to the public.



AKRAPOVIČ SINISTER SILENCER

- 3-outlet design exclusive to Can-Am.
- Finished in bold flat black carbon & stainless steel.
- Unique Akrapovič growl.
- Akrapovič Sinister Silencer Heat Shield Replacement Kit available (219400766).
- Not AS certified.

Spyder F3, F3-S
■ 219400701 - Black

AKRAPOVIČ SINISTER SILENCER HEAT SHIELD REPLACEMENT KIT

(Not illustrated)

Spyder F3, F3-S (service kit)
219400766



AKRAPOVIČ STRAIGHT SHOT SILENCER

- Premium chromed stainless steel shell construction, end cap and heat shields.
- Not AS certified.

Spyder F3, F3-S 2016 and prior
■ 219400514 - Chrome



AKRAPOVIČ SPORT TOURING 3C SILENCER

- Set your ride apart with the dynamic, deep resonant sound of an Akrapovič silencer.
- Its premium titanium and carbon fiber construction is 55% lighter than stock model and it's been tested to meet the most stringent requirements.
- Not AS certified.

Spyder F3-T, F3 Limited, RT 2015 and up
■ 219400838 - Titanium

UPGRADE YOUR GROWL

AKRAPOVIČ SILENCERS TOP FEATURES

- Deeper, more guttural sound than stock silencer.
- Meet the most stringent standards - EPA, CARB & EC certified.
- Maintain vehicle warranty requirements.
- Easy installation.
- Exhaust fit compatible with all BRP genuine accessories.

SPYDER RT ACCESSORIES



RT PASSENGER ARMRESTS 219400839



TRI AXIS ADJUSTABLE HANDLEBAR 219400344



AKRAPOVIČ SPORT TOURING 3C SILENCER 219400650 /
OUTSIDE NORTH AMERICA: 219400442

There are a thousand ways to trick out a Spyder RT.
Take a look at ours and let your imagination run wild.

RT COAST-TO-COAST ADVENTURE INSPIRED LOOK



RT LIMITED HIGHWAY MASTER INSPIRED LOOK DARK EDITION



U-FUNCTION

- 1 ADJUSTABLE VENTED WINDSHIELD P. 78
- 2 ADJUSTABLE DRIVER BACKREST FOR PRODUCTION SEAT P. 77
- 3 ADJUSTABLE SIDE WIND DEFLECTORS P. 79

U-STYLE

- 4 15" SHAMROCK WHEELS P. 84
- 5 MIRROR ACCENTS P. 86

U-PERFORMANCE

- 6 AKRAPOVIČ SPORT TOURING 3C SILENCER P. 89

U-FIT

- 1 TRI AXIS ADJUSTABLE HANDLEBAR P. 76

U-FUNCTION

- 2 LOW WINDSHIELD KIT P. 78
- 3 COMFORT SEAT P. 77
- 4 ADJUSTABLE DRIVER BACKREST FOR COMFORT SEAT P. 77
- 5 RT PASSENGER ARMRESTS P. 77

U-STYLE

- 6 LOW BROW FRONT FENDERS P. 85



U-FIT

IDLER PULLEY

RT IDLER PULLEY SERVICE KIT

(Not illustrated)
 · Enhances your comfort on the road by reducing vibrations generated by the belt.

Spyder RT models 2014 and up
219800419

HANDLEBARS

TRI AXIS ADJUSTABLE HANDLEBAR

- State-of-the-art adjustable handlebar reduces fatigue and delivers comfort for all riders thanks to unlimited adjustment possibilities.
- Three different axes allow you to adjust the handlebar in terms of height, width and arm distance.
- Left and right bars are linked together and rotate simultaneously during adjustment.
- Easy Allen key adjustment system.
- Handlebar reuses existing production handgrips, comodo, electrical and clutch cables, and sits directly on the stock steering column.
- GPS Support for the Tri Axis Adjustable Handlebar (219400616) sold separately.

All Spyder RT models

■ 219400344 · Carbon Black

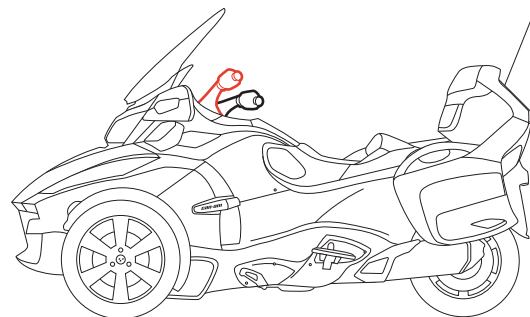

THREE DIFFERENT AXES ENABLE YOU TO ADJUST THE HANDLEBAR HEIGHT, WIDTH AND ARM DISTANCE.

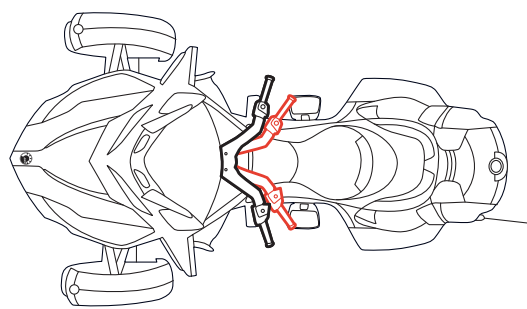

THE LEFT AND RIGHT SIDES OF THE BAR ARE LINKED SO THEY'RE ALWAYS IN SYNC.

U-FUNCTION

SEATS & BACKRESTS

NEW RT PASSENGER ARMRESTS

- The ultimate in long or short distance passenger comfort.
- Pivot up and out of the way for easy passenger access and exit.
- Styled to ensure an absolute match to your Can-Am Spyder.
- Allow easy access to passenger handles for added safety.

All Spyder RT models

■ 219400839 · Black



Moving the driver's seat position back just two inches (50 mm) relaxes the knees and upper body.



COMFORT SEAT

- Ultra comfortable with lumbar support.
- Roomier for driver, improves comfort during long rides.
- Driver backrest ready.
- Perfect for taller riders.

All Spyder RT models

■ 219400457 · Black

ADJUSTABLE DRIVER BACKREST FOR PRODUCTION SEAT

- New tilt adjustment to suit your riding style.
- Unique patent pending plug-and-go design installs in seconds and works with all standard Spyder RT driver seats with no modifications.
- Folds forward for easy passenger seat access.

Spyder RT 2014 and up, RT 2013 and prior with 2014 and up production seats

■ 219400679 · Black

ADJUSTABLE DRIVER BACKREST FOR COMFORT SEAT

- Tilt adjustment to suit your riding style.
- Unique patent pending plug-and-go design installs in seconds and works with Spyder RT driver Comfort Seats with no modification.
- Folds forward for easy passenger seat access.

Fits with Comfort Seat (219400457)
Fits with Heated Comfort Seat (219400398)

■ 219400689 · Black



HEATED COMFORT SEAT

- Heated comfort seat with ability to slide in the driver backrest.
- The driver and passenger can choose their own heat intensity.
- Dual range Hi/Low heat setting.
- Activated through stock passenger and driver heated grip controls.

Spyder RT 2014 and up

■ 219400398 · Black

ADJUSTABLE DRIVER BACKREST SUPPORT - UPGRADE KIT

- Kit adds tilt adjustment to previous generation driver backrests.

For production seats

219400682

For Comfort seats

219400683





WINDSHIELDS & WIND PROTECTION

YOUR CLIMATE CONTROL

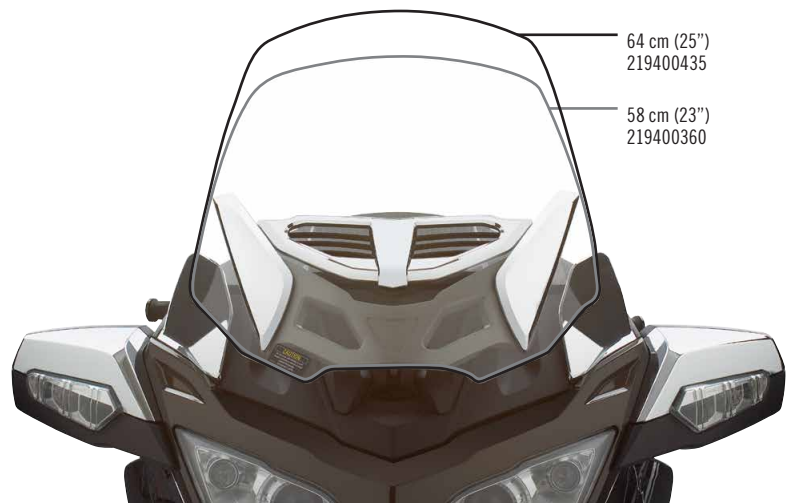

ADJUSTABLE VENTED WINDSHIELD

- Regulates driver frontal airflow.
- Integrated adjustable vent offers easy infinite management of horizontal slats from closed to fully opened.

All Spyder RT models

- 64 cm (25") 219400435 - Clear with chrome
- 58 cm (23") 219400360 - Clear with chrome

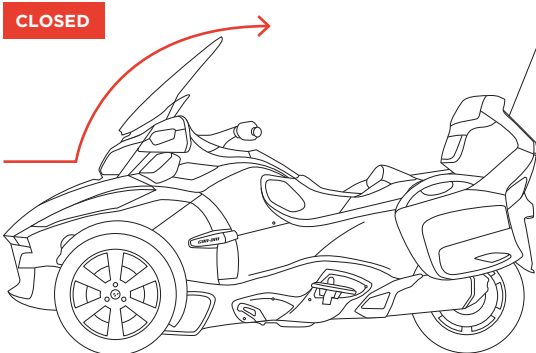
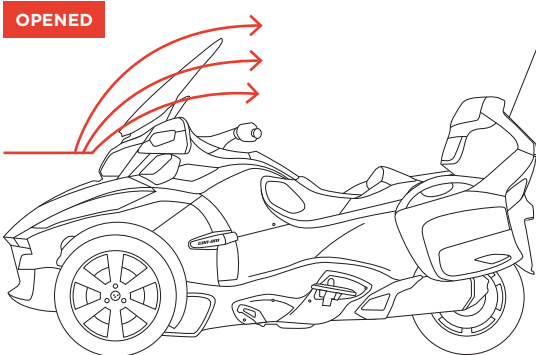

ADJUSTABLE SIDE WIND DEFLECTORS

- Regulate passenger and driver airflow.
- 3 preset positions (closed, parallel and inverted).
- Easy tool-less click adjustment.

All Spyder RT models

- 219400362 - Clear
- 219400413 - Chrome

3 ADJUSTABLE SIDE WIND DEFLECTORS PRESET POSITIONS

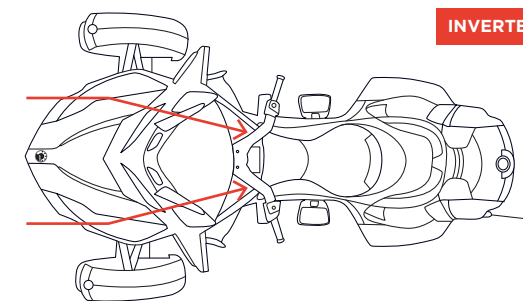
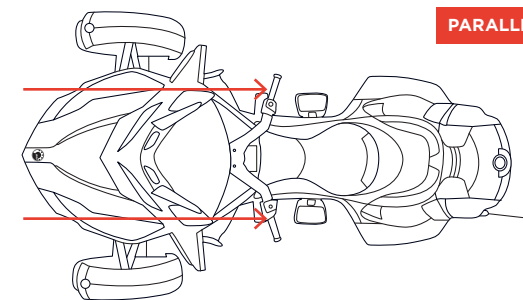
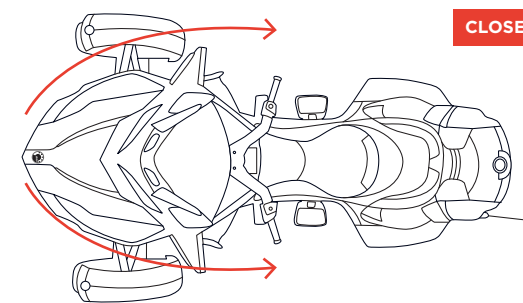

VENTED WINDSHIELD

- 2013-2014 standard windshield with openings.

All Spyder RT models

- 219400415 - Clear



LOW WINDSHIELD KIT

All Spyder RT models

- 219400578 - Smoke



TOURING WINDSHIELD

- Lower and narrower design for riders looking for less wind protection than provided by the stock Spyder RT model.

All Spyder RT models

- 64 cm x 61 cm (H 25" x W 24") 219800199 - Clear
- 58 cm x 56 cm (H 23" x W 22") 219400243 - Clear



CARGO & STORAGE

SEMI-RIGID REAR SIDE CARGO TRAVEL BAGS

- Stylish premium travel bags specifically sized to fit in rear side cargo.
- Retractable handle and shoulder straps for carrying convenience.
- Integrated pull tabs for effortless removal from cargo cavity.
- Sold in pairs.

All Spyder RT models

■ 219400169 - Black



SEMI-RIGID REAR TOP CARGO TRAVEL BAG

- Stylish premium travel bag specifically sized to fit in rear top cargo.
- Retractable handle for carrying convenience.
- Integrated pull tabs for effortless removal from cargo cavity.

All Spyder RT models

■ 219400168 - Black



TOP CASE MIRROR

- For rear top cargo cover.
- Folds open, locks up when not in use.
- Offers a small cargo in the top case lid.

All Spyder RT models

219400321



NEW INTEGRATED HELMET BAG

- Truly integrated easy-to-use helmet storage solution.
- Sturdy water-resistant construction.
- Includes elastic straps for tying down helmet bag onto seat.
- Complete with anti-theft wire for added security.

All Spyder F3 & RT models

■ 219400850 - Black



SOFT SIDE CARGO TRAVEL BAGS

- Soft travel bags that maximize Spyder RT rear side cargo space.
- Integrated handle for carrying convenience.
- Sold in pairs.

All Spyder RT models

■ 219400172 - Black



SOFT REAR TOP CARGO TRAVEL BAG

- Soft travel bag designed to maximize rear top cargo space.
- Integrated handle for carrying convenience.
- Rear Top Cargo Shelf (219400232) recommended for installation.

All Spyder RT models

■ 219400171 - Black



SEMI-RIGID FRONT CARGO TRAVEL BAG

- Rolling travel bag designed to maximize available front cargo space.
- Can also double as airplane carry-on luggage.

All Spyder RT models

■ 219400167 - Black



SOFT FRONT CARGO TRAVEL BAG

- Soft travel bag designed to maximize available front cargo space or stow in the Can-Am Freedom Trailer.
- Integrated handles for carrying convenience.
- Can also be used as a duffel bag.

All Spyder RT models, Can-Am Freedom Trailer

■ 219400170 - Black



REAR TOP CARGO SHELF

- For supporting and organizing rear top cargo.
- Two recessed compartments to support electronic accessories.
- Can be tilted to facilitate access to lower section of cargo.

All Spyder RT models

■ 219400232 - Black

FRONT CARGO LINER

- Felt insert provides finishing touch to front compartment.
- Features multiple storage pockets.
- Designed to integrate Front Cargo Light (219400623).

Spyder RT 2012 and prior

■ 219400166 - Black

Spyder RT 2013 and up

■ 219400368 - Black



FRONT CARGO LIGHT

- Light turns on as hood opens.

All Spyder RT models

219400623



TOP CASE MOLDED INSIDE LINER

- Felt insert for finishing touch to rear top cargo compartment.

All Spyder RT models

■ 219400246 - Dark Grey



LIGHTS & ELECTRICAL ACCESSORIES

CELLPHONE INTERFACE KIT

- Electrical harness tucked underneath vehicle allows you to communicate with your Bluetooth cellphone via your headset.
- Requires CB & Communication System (219400611), Entertainment Harness (219400610) and Garmin Zumo 590 GPS (219400512, 219400699 EC).



Spyder RT 2010-2017
219400390

BLUETOOTH DONGLE FOR AUDIO SYSTEM

- Allows a wireless Bluetooth connection between the vehicle's AM/FM radio (or any non-Bluetooth audio device) and the Bluetooth Communication System.
- Dual streaming to 2 Bluetooth headsets at the same time.
- Headset and AM/FM radio sold separately.



All Spyder RT models, ST 2010-2017
219400458

GPS SUPPORT FOR TRI AXIS ADJUSTABLE HANDLEBAR

- Support for Garmin Zumo 590 GPS.
- Rotates to suit multiple adjustable handlebar settings.
- Includes casting, electric harness, rubber boot and hardware.
- GPS sold separately.



All Spyder RT models

■ 219400616 · Carbon Black

CB & COMMUNICATION SYSTEM

- For staying in touch with friends across a range of 40 channels.
- Handlebar controls allow push-to-talk and adjust squelch levels for maximum performance and reception quality.
- Fully integrated system also mutes radio while in transmitting and receiving modes.
- Plug-and-play system controlled via vehicle's cluster.

- Works in conjunction with wired Communication Headset (4474380090).
- Entertainment Harness (219400610) required for installation.
- AM/FM Integrated Audio System (219400464) also required for Spyder RT 2012 and prior models.
- Not available in Europe.

Spyder RT 2010-2017
219400611



COMMUNICATION HEADSET (WIRED)

- For rider and passenger. Includes headset and microphone.
- Works in conjunction with the CB & Communication System (219400611) available as an option on the Can-Am Spyder RT models.



4474380090

PUSH-TO-TALK REMOTE FOR PASSENGER

- Passenger communication system (wired) for use with wired headsets and microphones (4474380090).
- Provides passenger with vehicle-to-vehicle communication capabilities with push-to-talk (PTT) button.
- Works in conjunction with the CB & Communication System (219400611), available as an option on the Can-Am Spyder RT models.



4474760090



GARMIN ZUMO 590 GPS

- Features a glove-friendly and sunlight-readable 12.7 cm (5") dual-orientation touchscreen display.
- Offers hands-free phone control and spoken directions heard in-helmet via Bluetooth 5 technology.
- Includes a MP3 player.
- iPod and Pandora compatibility.
- GPS Support sold separately (219400615/219400616).
- Allows control of music right on the display.
- Rugged and tough enough to withstand fuel spills, UV rays and harsh weather.
- Offers access to real-time weather and traffic information via the smartphone link app.
- Free lifetime map updates.
- Curvy Roads Routing allows rider to find winding roads.

All Spyder models

219400512

219400699 · Europe

ADJUSTABLE GPS MOUNTING KIT (FOR STOCK HANDLEBAR)

(Not illustrated)

- Mounting kit for Garmin Zumo 590 GPS (219400512, 219400699 EC) with adjustable support that fits stock handlebar.
- Includes casting, electric harness, rubber boot and hardware.

All Spyder RT models, RS, ST

■ 219400615 · Carbon Black

- The support conveniently swivels to offer the right position for all riders or light conditions.
- GPS sold separately.

GPS SUPPORT FOR TRI AXIS ADJUSTABLE HANDLEBAR (WITHOUT HARNESS)

(Not illustrated)

All Spyder RT models

219800382

CB ANTENNA REPLACEMENT KIT

(Not illustrated)

- Includes antenna, antenna base, ground strap and wires.

All Spyder RT models (service kit)

219400317

ENTERTAINMENT HARNESS

(Not illustrated)

- Required to install the CB & Communication System (219400611) and Satellite Radio Kit (219400612).

Spyder RT 2010-2017h

219400610



NEW CGX3 CAMERA

- 160° wide angle lens.
- Resolution options: from 3MP up to 20MP and VGA.
- Video resolutions available: 2.7K at 30 frames per second (FPS), 720P at 120/60/30 FPS, 1080P at 60/30 FPS and VGA at 240 FPS.
- Record videos in 4K UHD at 24 FPS, 2.7K QHD at 30 FPS and 720P at 120 FPS.
- Memory: Class 10 32GB micro SD card.
- 2" capacitive touchscreen.
- Waterproof up to 10 meters (32.8') without a case.
- Li-ion battery capacity of 1050mAh, working time of 1/1.5 hours and charging time of 3 hours (2 batteries included).
- WiFi function remotely operates up to 15 meters (49.2') with mobile devices and CYCLOPS app for Android and IOS.
- Features modes such as invert, time lapse, high speed & loop recording, motion detection, capture (while recording a video), burst and anti-sharing.
- Comes with 8 mounting accessories.

9700130090



SATELLITE RADIO KIT

- Receiver helps maintain radio reception everywhere.
- 150+ digital channels to choose from.
- 15 station presets for quickly tuning into your favorite programming.
- Plug-and-play system controlled via vehicle's cluster.
- Fee-based monthly subscription required.
- Entertainment Harness (219400610) required for installation.
- AM/FM Integrated Audio System (219400464) is also required for Spyder RT 2012 and prior.
- Headset sold separately.
- Not available in Europe.

Spyder RT 2010-2017

219400612

3.5 MM AUDIO PLAYER INPUT

- 3.5 mm cable for hooking up a MP3 player to top cargo's DIN connector.
- Driver volume control convenience through vehicle's cluster.



Spyder RT 2014 and up, ST

710001406

POWER OUTLET KIT

- Recharges your electronic devices while riding* (smartphone, MP3, heating gear, etc.).
- Dual port USB connectors.
- Plug-and-play kit.
- Simply connect under driver seat and use.
- *The power outlet is not capable of recharging all device types while riding.

All Spyder RT models, RS, ST, F3, F3-S

219400510 - USB

- Adds an extra 12V power outlet to your vehicle.

- Conveniently located in front cargo bin.

All Spyder models

219400366 · 12V



FOG LIGHTS

(Not illustrated)

- Enhance low beam light for better visibility at ground level and on sides.
- Uniquely styled halogen fog lamps feature a 35W bulb and clear lens with a faceted inner reflector.
- Easy installation.
- Not EC compliant.

All Spyder RT models

219400579



CYCLOPS 360° PANORAMIC HD VIDEO CAMERA

- Features a 220-degree wide-angle lens.
- Video resolutions up to 4K at 30 frames per second.
- Professional 16MP quality photos.
- Rugged, light and portable.
- Magnetic mount for vibration-free footage and mounting to any metal surface.
- Comes with 32GB Class 10 micro SD card.
- Waterproof case up to 50 meters (164').
- Wi-Fi available to remotely control your camera from your smartphone or computer with the free CGX2 App.
- 16 modes and effects, including driving mode, loop recording, time lapse and slow motion.
- Comes with 10 mounting accessories.
- Compatible with VR goggles.

9700020090

PASSENGER SPEAKER & AUDIO CONTROLS

- Weatherproof concert-sound-quality rear speaker kit including speakers, pods and passenger controls for full radio tuning.
- Plug-and-play directly into vehicle.
- Fully-equipped wiring harness included.



Spyder RT 2012 and prior

219400150

IPOD INTEGRATION CABLE

- Cable for hooking up an iPod (30 pin connector common to Apple devices) to top cargo's DIN connector.
- Includes 5V transformer.
- Full-feature handlebar control.
- DOT-Matrix visual interface.
- Driver volume control and playlist browser convenience through vehicle's cluster.
- An adapter may be required for latest-generation iPod or iPhone.
- Standard on Spyder RT and ST Limited packages.
- Located in the front compartment on Spyder ST and in rear compartment on Spyder RT.
- Check compatibility with your dealer.

Spyder RT 2014 and up, ST

710002676



5-LED FRONT HEADLAMP ACCENT LIGHTING KIT

(Not illustrated)

- Additional luminescence for improved visibility and more spectacular arrivals.
- Not EC compliant.

All Spyder RT models

219400188

REPLACEMENT N-TOUCH COVERS FOR COMMUNICATION SYSTEM DIN CONNECTORS

(Not illustrated)

All Spyder RT models (service kit)

■ 219400315 · Black



U-STYLE

WHEELS



15" SHAMROCK WHEELS

- Add personality to your Can-Am Spyder.
- Casted, painted and machined wheels.
- Sold in pairs.

All Spyder F3 and RT models, RS, ST 2013 and up

■ 219400500 · Deep Black



15" FAT 6 CHROME WHEELS

- Same design as Spyder F3 production wheels in PVD finish.
- Sold in pairs.

All Spyder F3 and RT models, RS, ST 2013 and up

■ 219400589 · Chrome



CHROME REAR WHEEL

- 6-spoke PVD — chrome-like powder-coat, more resistant than regular chrome — monobloc rear wheel (hub and wheel in one piece).

All Spyder F3 and RT models, RS, ST 2013 and up

■ 219400574 · Chrome

All Spyder 2012 models and prior

■ 219400575 · Chrome



15" 2014 RS-S MAG WHEELS

- Painted and machined.
- Sold in pairs.

All Spyder F3 and RT models, RS, ST 2013 and up

■ 219400418 · Carbon Black



15" RT-S FRONT WHEELS

- Premium cast aluminum 15" 12-spoke mags.
- Sold in pairs.

All Spyder F3 and RT models, RS, ST 2013 and up

■ 219400419 · Carbon Black



15" RT FRONT WHEELS

- 15" 12-spoke mags.
- Sold in pairs.

All Spyder F3 and RT models, RS, ST 2013 and up

■ 219400365 · Grey



15" RT & ST LIMITED CHROME FRONT WHEELS

- Premium cast aluminum 15" 12-spoke mags.
- Sold in pairs.

All Spyder F3 and RT models, RS, ST 2013 and up

■ 219400420 · Chrome



15" RS & ST FRONT WHEELS

- 15" 6-dual-spoke mags.
- Sold in pairs.

All Spyder F3 and RT models, RS, ST 2013 and up

■ 219400417 · Grey



14" CHROME WHEELS

- Sold in pairs.

Spyder RT 2012 and prior

■ 219400256 · Chrome



15" RS-S & ST-S FRONT WHEELS

- Premium cast aluminum 15" 6 twin-blade spoke mags.
- Sold in pairs.

All Spyder RT models, RS, ST 2013 and up
all Spyder F3 models

■ 219400357 · Carbon Black



15" BLADE MAG WHEELS

- Unidirectional design (left and right wheel).
- Patented casting process allows a weight reduction of 1 kg (2.2 lbs) per wheel compared to stock wheels.
- Sold in pairs.

All Spyder F3 and RT models, RS, ST 2013 and up

■ 219400465 · Black

15" BLADE MAG WHEELS SERVICE KIT

(Not illustrated)

- Replacement "blade" for wheels.

■ 219400542

Left · Brushed Aluminum

■ 219400543

Right · Brushed Aluminum

WHEEL NUT KIT

(Not illustrated)

- Pack of 6.

All Spyder models

■ 219400451 · Black

■ 219400452 · Grey

FENDERS



You can make any year Can-Am Spyder look like the latest by simply changing the fenders.



LOW BROW FRONT FENDERS

- Super sleek drawn steel fenders with LED position lights integrated into the front edge.
- Include electrical harness and required hardware.
- Sold in pairs.
- LED position lights not EC homologated.

All Spyder F3 and RT models, RS, ST 2013 and up

■ 219400502 · Carbon Black



FRONT FENDERS

- Sporty look with a slim profile and integrated position lights and reflectors.
- Front Fender Supports (219400359) are required (sold separately).
- Sold in pairs.

All Spyder F3 and RT models, RS, ST 2013 and up

■ 219400423 · Pure Magnesium

■ 219400424 · Satin Black

□ 219400467 · Pearl White



FRONT FENDER SUPPORTS

- Supports for Front Fenders, including position lights, reflectors and hardware.
- Front Fenders sold separately.
- Sold in pairs.

All Spyder F3 and RT models, RS, ST

■ 219400359 · Black



CUSTOM ACCESSORIES

WINDSHIELD SUPPORT

· Complete with mounting hardware.

All Spyder RT models

■ 219400298 · Chrome



MIRROR ACCENTS

· Chrome accents to upgrade your mirrors.
· Sold in pairs.

All Spyder RT models

■ 219400291 · Chrome



WINDSHIELD TRIM

All Spyder RT models

■ 219400191 · Chrome



AIR INTAKE TRIMS

· Sold in pairs.

All Spyder RT models (except models with Fog Lights)

■ 219400196 · Chrome



LOWER WIND DEFLECTORS

· Hardware included.
· Sold in pairs.

All Spyder RT models

■ 219400290 · Chrome



UPPER WIND DEFLECTORS

· Hardware included.
· Sold in pairs.

All Spyder RT models

■ 219400262 · Chrome



HANDLEBAR COVER

· Complete with hardware and black center cap.

All Spyder RT models

■ 219400263 · Chrome



HANDLEBAR END CAPS

· Sold in pairs.

All Spyder models

■ 219400702 · Chrome



FOOTPEG SUPPORT CASTINGS

· Remounting hardware included.
· Peg and footboard sets sold separately.
· Sold in pairs.

Spyder RT 2012 and prior

■ 219400268 · Chrome



LOWER SPOILER TRIMS

· Sold in pairs.

Spyder RT 2013 and prior

■ 219400194 · Chrome



SIDE CAN-AM TRIMS

· Sold in pairs.

All Spyder RT models

■ 219400195 · Chrome



REAR TOP CARGO TRIM

All Spyder RT models

■ 219400192 · Chrome



DRIVER FOOTBOARDS

· Replace stock pegs on SE5 and SE6 models.
· Sold in pairs.

Spyder RT-S SE5, SE6 2013 and up

■ 219400582 · Chrome



DRIVER FOOTPEGS

· Chrome pegs assembled with rubber insulated pads.
· Mounting hardware included.
· Sold in pairs.

All Spyder RT models

■ 219400264 · Chrome



PASSENGER FOOTBOARDS

· Complete chrome passenger footboards assembled with rubber insulation pads.
· Mounting hardware included.
· Sold in pairs.

All Spyder RT models

■ 219400265 · Chrome

EXHAUST TIP AND HEAT SHIELD

· Kit for custom finishing your stock exhaust system.
· Includes chrome end pipe, heat shield and hardware.

All Spyder RT models, RS, ST, F3-T, F3 Limited

■ 219400473 · Chrome





U-PERFORMANCE

SHOCKS



FOX ADJUSTABLE FRONT SHOCK KIT

- Velocity sensitive, bolt on suspension upgrade specially tuned for Spyder RT.
- Includes stiffer springs and adjustable preload to adapt to your riding style and reduce body roll.
- Fully serviceable and rebuildable.
- Part of the Podium Performance Series, delivers great performance and comfort.

Spyder RT 2014 and up
219400588

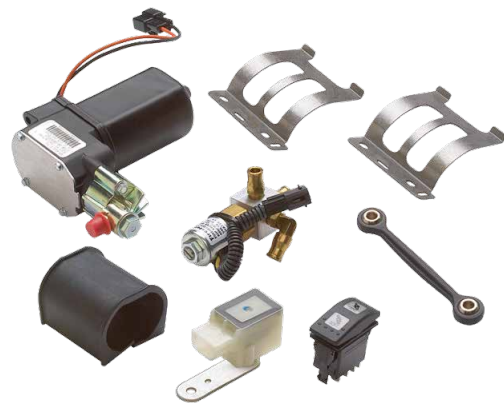

ADJUSTABLE AIR REAR SUSPENSION KIT

- Upgrades suspension comfort to Spyder RT-S premium automated level.
- Includes air compressor, adjustment switch and all required hardware.
- When installing this kit on model year 2010 and 2011, an ACS switch (710001960) must be ordered to have the same blue backlight.

Spyder RT 2012 and up
219400539

SILENCERS



All Can-Am Spyder accessory exhaust systems meet all the most stringent EPA, CARB & EC standards.



AKRAPOVIČ SPORT TOURING SILENCER

· Not AS certified.
Spyder RT 2013, RS, ST 2013 and up (991 engine)
219400443 · Titanium



AKRAPOVIČ SPORT SILENCER

· Not AS certified.
Spyder RT 2013, RS, ST 2013 and up (991 engine)
219400444 · Titanium



AKRAPOVIČ SPORT TOURING 3C SILENCER

- Set your ride apart with the dynamic, deep resonant sound of an Akrapovič silencer.
- Its premium titanium and carbon fiber construction is 55% lighter than stock model and it's been tested to meet the most stringent requirements.
- Not AS certified.

All Spyder RT models, F3-T, F3 Limited
219400838 · Titanium



AKRAPOVIČ SILENCERS TOP FEATURES

- Innovative Design. First hexagonal shaped silencers.
- The best materials. Premium titanium shell construction with carbon fiber end cap and heat shield render these silencers 55% lighter than the stock silencer.
- The unmistakable sound of Akrapovič. Deep resonant sound that you won't hear anywhere else.
- EPA, CARB and EC certified. Rigorous measurement, testing and quality control ensure silencers meet the most stringent standards.
- Exhaust fit compatible with all BRP genuine accessories.

SPYDER RS & ST ACCESSORIES

AKRAPOVIČ SPORT SILENCER 219400444



ULTRASPORT WINDSHIELD 219400077



TOP CASE 219400476

U-FUNCTION

SEATS & BACKRESTS



COMFORT SEAT

- Premium plush styling with stitched seat skin.
- Custom saddle look and relaxed sitting position.
- Increases driver and passenger comfort and reduces tailbone pressure.
- Ideal for driving long distances.
- Sold as complete seat assembly.
- Product may differ from picture shown.

Spyder RS, ST

219400416 - Black



PASSENGER BACKREST

- One piece fixed passenger backrest with latest ergonomics, high and wide, providing superior lateral support.
- Removes in seconds back to original sport look.
- Rear cover included.

Spyder RS, ST

219400350 - Carbon Black

WINDSHIELDS & WIND PROTECTION

SPORT TOURING WINDSHIELD

- 36 cm (14").
- Makrolon[®] polycarbonate custom windshield.

Spyder RS

219400075 - Clear

ULTRASPORT WINDSHIELD

- 10" (25 cm).
- Makrolon polycarbonate windshield with blackened-out «V» shape profile.
- Easy installation.

Spyder RS

219400077 - Smoke

ULTRA TOURING WINDSHIELD KIT

- Ultra protective windshield and casting support.
- Constructed with Quantum hardcoated 4.5 mm Lexan[®] polycarbonate.
- Windshield design is spaced away from pod reducing backdraft pressure.
- Service Kit (219400204) is recommended to mount this windshield.

Spyder RS

58 cm (23")

219400285 - Clear - Ideal for drivers under 1.75 meters (5'10").

64 cm (25")

219400336 - Clear - Ideal for drivers over 1.75 meters (5'10").

ULTRA TOURING WINDSHIELD SERVICE KIT

(Not illustrated)

Spyder RS

219400204

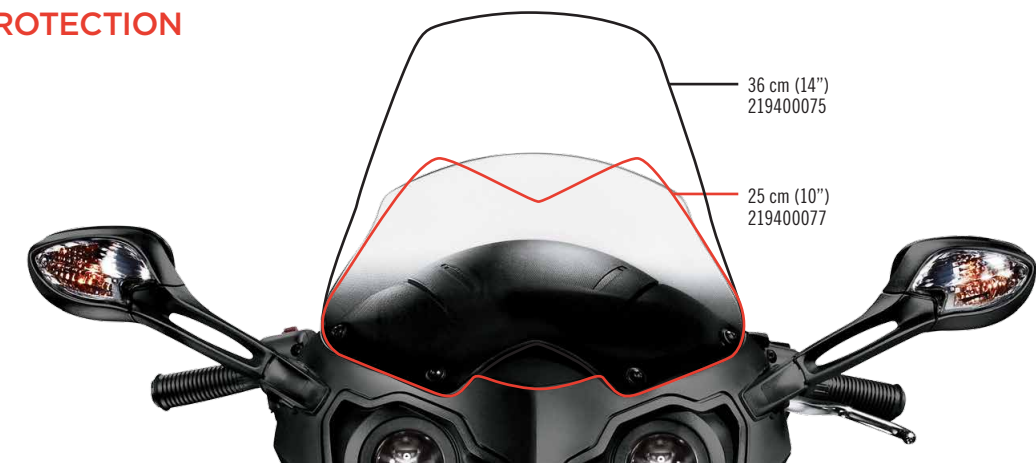

Some products may not be available or homologated in your region. Contact your dealer for more information.



CARGO & STORAGE

R-35 RIGID SADDLEBAG KIT

- Provides carry-away convenience for additional luggage storage.
- Clean finish courtesy of fully integrated flush mount brackets with quick release system.
- Quick release quarter-turn system provides security and removal in minutes when saddlebags are not required.
- Side case utilizes Monokey® side fitting system.
- Opens/closes and attaches/detaches with one key and push button for ease of use.

- Volume capacity of 9 US gallons (34 L) (e.g. fits 2 Can-Am full face helmets).
- Weight capacity of 15 lbs (6.8 kg) each side.
- Dimensions W 21" x D 12" x H 15.5" (53 cm x 30 cm x 39 cm).
- Kit includes 2 saddlebags.
- Color-matched panels sold separately.
- Standard on Spyder ST Limited package.

Spyder RS, ST

- 219400351 - Black
- 219400352 - Black - Europe - EC compliant



Unlike competing saddlebags, Can-Am Spyder saddlebags ensure you maintain your vehicle's warranty.



R-35 SADDLEBAG PANEL KIT

- Sold in pairs.
- EC compliant.

Spyder RS, ST

- 219400174 - Yellow
- 219400175 - Roadster Red
- 219400178 - Full Moon Silver
- 219400222 - Pearl White
- 219400292 - Pure Magnesium

- 219400293 - Alloy Orange
- 219400375 - Can-Am Red
- 219400377 - Steel Black Metallic
- 219400461 - Circuit Yellow

TOP CASE

- Rear luggage that mounts directly on Passenger Backrest (219400350), sold separately.
- 33 liters (8.7 US gallons) capacity.
- Installs and removes in minutes.

Spyder ST

- 219400476 - Black



PASSENGER SEAT BAG

- 22.3 liters (5.9 US gallons) capacity.
- Durable 1200-denier nylon construction with polyurethane coating.
- For use on passenger seat, also fits in front storage compartment.

Spyder RS, ST

- 280000320 - Dark Grey



ROLLING TRAVEL BAG

- Premium bag with extendable handle.
- Fits conveniently in front storage compartment.

Spyder RS, ST

- 219400098 - Grey



R-35 SADDLEBAG REAR REFLECTOR KIT

(Not illustrated)

- Spyder RS, ST (service kit) 219400235



Windshields aren't just for warmth - they play a big role in your Can-Am Spyder ST's styling.



64 cm (25")
219400354



38 cm (15")
219400353

ULTRA TOURING WINDSHIELD

- Taller and slightly wider than stock windshield to ensure maximum wind protection.
- 5 height settings to adjust for more or less wind protection as needed.
- Service Kit (219800352) is recommended to mount this windshield.

Spyder ST

- 219400354 - Clear

SPORT WINDSHIELD

- Sporty look.
- 5 height settings to adjust for more or less wind protection than stock model.

Spyder ST

- 219400353 - Clear

ULTRA SPORT POD COVER

- Sleek pod cover that provides a super sporty look by replacing the stock windshield and its adjustment mechanism.

Spyder ST

- 219400447 - Black



LIGHTS & ELECTRICAL ACCESSORIES



FOG LIGHTS

WITHOUT THE FOG LIGHTS



WITH THE FOG LIGHTS



FOG LIGHTS

- Enhance low beam light for better visibility at ground level and on sides of your vehicle.
- Uniquely styled halogen fog lamps feature a 35W bulb and clear lens with a faceted inner reflector.
- Harness included.
- Easy installation.
- Not compatible with EC homologated vehicles.
- Not EC compliant.

Spyder RS, ST 2013 and up
219400614

GARMIN ZUMO 590 GPS

- Features a glove-friendly and sunlight-readable 12.7 cm (5") dual-orientation touchscreen display.
- Offers hands-free phone control and spoken directions heard in-helmet via Bluetooth 5 technology.
- Includes a MP3 player.
- iPod and Pandora compatibility.
- Allows control of music right on the display.

All Spyder models
219400512
219400699 - Europe

- Rugged and tough enough to withstand fuel spills, UV rays and harsh weather.
- Offers access to real-time weather and traffic information via the smartphone link app.
- Free lifetime map updates.
- Curvy Roads Routing allows rider to find winding roads.
- Adjustable GPS Mounting Kit (219400615) sold separately.



ST RADIO KIT

- (Not illustrated)
- Easy access handlebar controls, menu driven display. Kit includes radio module, antenna and 2 front speakers.

Spyder ST
219400521



NEW CGX3 CAMERA

- 160° wide angle lens.
- Resolution options: from 3MP up to 20MP and VGA.
- Video resolutions available: 2.7K at 30 frames per second (FPS), 720P at 120/60/30 FPS, 1080P at 60/30 FPS and VGA at 240 FPS.
- Record videos in 4K UHD at 24 FPS, 2.7K QHD at 30 FPS and 720P at 120 FPS.
- Memory: Class 10 32GB micro SD card.
- 2" capacitive touchscreen.
- Waterproof up to 32.8 (10 m) without a case.
- Li-ion battery capacity of 1050mAh, working time of 1/1.5 hours and charging time of 3 hours (2 batteries included).
- WiFi function remotely operates up to 15 meters (49.2') with mobile devices and CYCLOPS app for Android and IOS.
- Features modes such as invert, time lapse, high speed & loop recording, motion detection, capture (while recording a video), burst and anti-sharing.
- Comes with 8 mounting accessories.

97000130090



CYCLOPS 360° PANORAMIC HD VIDEO CAMERA

- Features a 220-degree wide-angle lens.
- Video resolutions up to 4K at 30 frames per second.
- Professional 16MP quality photos.
- Rugged, light and portable.
- Magnetic mount for vibration-free footage and mounting to any metal surface.
- Comes with 32GB Class 10 micro SD card.
- Waterproof case up to 164' (50 m).
- Wi-Fi available to remotely control your camera from your smartphone or computer with the free CGX2 App.
- 16 modes and effects, including driving mode, loop recording, time lapse and slow motion.
- Comes with 10 mounting accessories.
- Compatible with VR goggles.

9700020090



ADJUSTABLE GPS MOUNTING KIT (FOR STOCK HANDLEBAR)

- Mounting kit for Garmin Zumo 590 GPS (219400512, 219400699 EC) with adjustable support that fits stock handlebar.
- Includes casting, electric harness, rubber boot and hardware.
- The support conveniently swivels to offer the right position for all riders or light conditions.
- GPS sold separately.

All Spyder RT models, RS, ST
219400615 - Carbon Black



HEATED DRIVER GRIPS

- Complete driver heating kit with variable intensity control.
- Provide extra warmth during cooler riding season.

Spyder ST
219400613



BLUETOOTH DONGLE FOR AUDIO SYSTEM

- Allows a wireless Bluetooth connection between the vehicle's AM/FM radio (or any non-Bluetooth audio device) and the Bluetooth Communication System.
- Dual streaming to 2 Bluetooth headsets at the same time.
- Headset and AM/FM radio sold separately.

All Spyder RT models, ST 2013 and up
219400458



POWER OUTLET KIT

- Recharges your electronic devices while riding* (smartphone, MP3, heating gear, etc.).
 - Dual port USB connectors.
 - Plug-and-play kit.
 - Simply connect under driver seat and use.
- *The power outlet is not capable of recharging all device types while riding.

All Spyder RT models, RS, ST, F3, F3-S
219400510 - USB

- Adds an extra 12V power outlet to your vehicle.
- Conveniently located in front cargo bin.

All Spyder models
219400366 - 12V



IPOD INTEGRATION CABLE

- Cable for hooking up an iPod (30 pin connector common to Apple devices) to top cargo's DIN connector.
- Includes 5V transformer.
- Full-feature handlebar control.
- DOT-Matrix visual interface.
- Driver volume control and playlist browser convenience through vehicle's cluster.
- An adapter may be required for latest-generation iPod or iPhone.
- Standard on Spyder RT and ST Limited packages.
- Located in the front compartment on Spyder ST and in rear compartment on Spyder RT.
- Check compatibility with your dealer.

Spyder RT 2014 and up, ST
710002676



3.5 MM AUDIO PLAYER INPUT

- 3.5 mm cable for hooking up a MP3 player to top cargo's DIN connector.
- Driver volume control convenience through vehicle's cluster.
- Located in the front compartment on Spyder ST and in rear top cargo on Spyder RT.

Spyder RT 2014 and up, ST
710001406



★ U-STYLE

WHEELS



15" 2014 RS-S MAG WHEELS

- Painted and machined.
- Sold in pairs.
- Standard on 2014 Spyder RS-S package.

All Spyder F3 and RT models, RS, ST 2013 and up

■ 219400418 - Carbon Black



15" RT-S FRONT WHEELS

- Premium cast aluminum 15" 12-spoke mags.
- Sold in pairs.

All Spyder F3 and RT models, RS, ST 2013 and up

■ 219400419 - Carbon Black



15" RT FRONT WHEELS

- 15" 12-spoke mags.
- Sold in pairs.

All Spyder F3 and RT models, RS, ST 2013 and up

■ 219400365 - Grey



15" RS-S & ST-S FRONT WHEELS

- Premium cast aluminum 15" 6 twin-blade spoke mags.
- Sold in pairs.

All Spyder F3 and RT models, RS, ST 2013 and up

■ 219400357 - Carbon Black



15" RT & ST LIMITED CHROME FRONT WHEELS

- Premium cast aluminum 15" 12-spoke mags.
- Sold in pairs.

All Spyder F3 and RT models, RS, ST 2013 and up

■ 219400420 - Chrome



15" RS & ST FRONT WHEELS

- 15" 6-dual-spoke mags.
- Sold in pairs.

All Spyder F3 and RT models, RS, ST 2013 and up

■ 219400417 - Grey



15" BLADE MAG WHEELS

- Unidirectional design (left and right wheel).
- Patented casting process allows a weight reduction of 1 kg (2.2 lbs) per wheel compared to stock wheels.
- Sold in pairs.

All Spyder F3 and RT models, RS, ST 2013 and up

■ 219400465 - Black



15" SHAMROCK WHEELS

- Add personality to your Can-Am Spyder.
- Casted, painted and machined wheels.
- Sold in pairs.

All Spyder F3 and RT models, RS, ST 2013 and up

■ 219400500 - Deep Black



15" FAT 6 CHROME WHEELS

- Same design as Spyder F3 production wheels in PVD finish.
- Sold in pairs.

All Spyder F3 and RT models, RS, ST 2013 and up

■ 219400589 - Chrome

15" BLADE MAG WHEELS SERVICE KIT

(Not illustrated)

- Replacement "blade" for wheels.

■ 219400542 - Left - Chrome

■ 219400543 - Right - Chrome

CHROME REAR WHEEL

- 6-spoke PVD - chrome-like powder-coat, more resistant than regular chrome - monobloc rear wheel (hub and wheel in one piece).

All Spyder F3 and RT models, RS, ST 2013 and up

■ 219400574 - Chrome

All Spyder 2012 models and prior

■ 219400575 - Chrome



WHEEL NUT KIT

(Not illustrated)

- Pack of 6.

All Spyder models

■ 219400451 - Black

■ 219400452 - Grey



FRONT FENDERS

- Sporty look with a slim profile and integrated position lights and reflectors.
- Front Fender Supports (219400359) are required (sold separately).
- Sold in pairs.

All Spyder F3 and RT models, RS, ST 2013 and up

- 219400423 - Pure Magnesium
- 219400424 - Satin Black
- 219400467 - Pearl White



LOW BROW FRONT FENDERS

- Super sleek drawn steel fenders with LED position lights integrated into the front edge.
- Include electrical harness and required hardware.
- LED position lights not EC homologated.
- Sold in pairs.

All Spyder F3 and RT models, RS, ST 2013 and up

- 219400502 - Carbon Black



SPORT REAR FENDER

- Provides a pure sport look while showing off the massive rear tire girth for an awesome visual.
- Includes fender, lateral covers, license plate relocater and light.
- Not EC homologated.

Spyder RS, ST

- 219400400 - Black



FRONT FENDER SUPPORTS

- Supports for Front Fenders, including position lights, reflectors and hardware.
- Front Fenders sold separately.
- Sold in pairs.

All Spyder RT models, RS, ST

- 219400359 - Black



MIRROR ACCENTS

- Replace stock mirror accents.
- Sold in pairs.

Spyder ST

- 219400401 - Chrome

UPPER WIND DEFLECTORS

- Replace stock clear upper wind deflectors.

Spyder ST

- 219400386 - Chrome

WINDSHIELD TRIMS

- Sold in pairs.

Spyder ST, F3, F3-S

- 219400355 - Chrome

EXHAUST TIP AND HEAT SHIELD

- Kit for custom finishing your stock exhaust system.
- Includes chrome end pipe, heat shield and hardware.

All Spyder RT models, RS, ST, F3-T, F3 Limited

- 219400473 - Chrome



HANDLEBAR END CAPS

- Sold in pairs.

All Spyder models

- 219400702 - Chrome



PROMOTIONAL STICKERS

- Multi-use vinyl stickers.
- Ideal for showing your Can-Am Spyder colors everywhere you go.
- Sold in pack of 4.

219400099





UPGRADE YOUR GROWL

AKRAPOVIČ SILENCERS TOP FEATURES

- Innovative Design. First hexagonal shaped silencers.
- The best materials. Premium titanium shell construction with carbon fiber end cap and heat shield render these silencers 55% lighter than the stock silencer.
- The unmistakable sound of Akrapovič. Deep resonant sound that you won't hear anywhere else.
- EPA, CARB and EC certified. Rigorous measurement, testing and quality control ensure silencers meet the most stringent standards.
- Exhaust fit compatible with all BRP genuine accessories.

SILENCERS

AKRAPOVIČ SPORT TOURING SILENCER

- Not AS certified.

Spyder RT 2013, RS, ST 2013 and up (991 engine)

■ 219400443 - Titanium



AKRAPOVIČ SPORT SILENCER

- Not AS certified.

Spyder RT 2013, RS, ST 2013 and up (991 engine)

■ 219400444 - Titanium



U-PERFORMANCE

SHOCKS

FOX ADJUSTABLE SHOCK KIT WITH SWAY BAR

- Fully adjustable gas-charged front FOX Podium 145 mm (5.7") racing shocks.
- Kit complete with a high performance sway bar.

Spyder RS, ST 2013

219400409

Spyder RS 2011-2012

219400403



COVERS

SPYDER F3

F3-T TRAILERING COVER

- Made of durable, 100% waterproof, fully-breathable 300-denier polyester.
- Easy-on / easy-off system ensures cover is secure in all trailering conditions.
- Equipped with integrated exhaust panel and no-scratch flannel windshield liner.
- Compatible with all stock and accessory regardless of passenger or driver backrest, passenger armrest, or windshields.
- Incompatible with top case.

Spyder F3-T, F3 Limited 2016

■ 219400751 · Black



F3 LIMITED TRAILERING COVER

- Made of durable, 100% waterproof, fully-breathable 300-denier polyester.
- Easy-on / easy-off system ensures cover is secure in all trailering conditions.
- Equipped with integrated exhaust panel and no-scratch flannel windshield liner.
- Compatible with all stock and accessory seats regardless of passenger or driver backrest, passenger armrest, windshield, or top case.

F3-T (with optional top case),

F3 Limited 2017 & up

■ 219400768 · Black



DRIVER SEAT RAIN COVER

- 100% waterproof driver-seat protection.
- Fits all stock or accessory seats.
- Compatible with Driver Backrest.
- Quick installation and removal.

All Spyder F3 models

■ 219400648 · Black



OUTDOOR COVER

- Durable solution-dyed UV and mildew-resistant 100-denier polyester construction.
- Soft inner liner protects windshields up to Tall Boy Windshield (219400596).
- Compatible with F3-T with or without passenger and driver backrests.
- Also compatible with all F3 windshields.
- Incompatible with passenger armrests (219400726).

Spyder F3-T, F3 Limited 2016

■ 219400603 · Black



TRAVEL COVER

- Start your morning ride with a dry, clean seat.
- Protects the top surfaces of your vehicle and stows compactly in the front compartment, making it a great road trip companion.

Spyder F3-T, F3 Limited 2016

■ 219400604 · Black



PASSENGER SEAT RAIN COVER

- 100% waterproof passenger seat protection.
- Fits all stock or accessory seats.
- Compatible with Passenger Backrest and Short Rail.
- Quick installation and removal.

Spyder F3, F3-S and F3-T standard seat, Coast-to-coast Seat, Cannonball seat

■ 219400649 · Black



OUTDOOR COVER

- Durable solution-dyed UV and mildew-resistant 100-denier polyester construction.
- Inner liner protects windshield.
- Easy maintenance.

Spyder F3, F3-S

■ 219400495 · Black



TRAVEL COVER

- Provides protection to vehicle's top areas.
- Stows conveniently into front bin and takes up little space.
- Easy to install and remove.

Spyder F3, F3-S

■ 219400496 · Black



SPYDER RT



SEAT RAIN COVER

- 100% waterproof seat protection.
- Fits all stock or accessory seats.
- Compatible with Driver Backrest.
- Quick installation and removal.

All Spyder RT models

■ 219400722 · Black



TRAVEL COVER

- Provides protection to vehicle's top areas (windshield, seat, top cargo).
- Stows conveniently into top cargo and takes up little space.
- Quick installation and removal.

All Spyder RT models

■ 219400199 · Black



NEW CUSTOM VEHICLE COVER

- Made of tough water-repellent, breathable 300-denier polyester.
- This cover provides maximum vehicle protection while trailering or outdoor storing.
- Includes integrated exhaust panel and protective flannel windshield liner.
- Easy attach system secures cover in all trailering conditions.
- Compatible with RT Passenger Armrests (219400839).

All Spyder RT models

■ 219400860 · Black

SPYDER RS & ST



LIGHT TRAVEL COVER

- Provides vehicle's seating, handlebar and windshield areas with outdoor temporary/overnight protection.
- Compact size makes it convenient for traveling.

Spyder RS

■ 219400275 · Black

Spyder RS, ST

■ 219400449 · Black



OUTSIDE STORAGE COVER

- Durable solution-dyed UV and mildew-resistant 100-denier polyester construction.
- Inner liner protects hood and windshield.
- Easy maintenance.
- Fits models with Ultra Touring Windshields (219400306/ 219400354) and Passenger Backrest (219400350).

Spyder RS, ST

■ 219400448 · Black



INDOOR STORAGE COVER

- Soft, non-abrasive, breathable polyester construction allows condensation to escape when vehicle is in storage.
- Easy clean fabric with Scotchgard® treatment.

Spyder RS

■ 280000338 · Black



TIE-DOWN KIT

- Specifically designed to secure your Can-Am Spyder while trailering.
- Attach your vehicle to 3 or 4 anchor points, depending on your trailer.
- Pack of 4.

219400200

GENUINE BRP PARTS.

BY USING ORIGINAL BRP PARTS,
YOU ARE TAKING CARE OF YOUR INVESTMENT.
MAKE THE RIGHT CHOICE.



AIR FILTERS

- Prevent airborne contaminants from reaching your engine.
- Protect internal components against premature wear.

Spyder RS 2008-2012
707800188

Spyder RS 2013 and up, Spyder RT with 998 cc engine 2010-2013, all Spyder ST models
707800306

All Spyder models with 1330 engine
707800483



BRAKE PAD KITS

- Brembo® brake systems are considered to be the benchmark for quality and innovation, delivering the ultimate in performance, comfort, quiet, and durability.

Spyder 2013 and up
219800237 - Front
219800239 - Rear

- Provide excellent performance, quiet, and durability in all road conditions.

Spyder 2012 and prior
219800164 - Front

219800165 - Rear



TIRES

- Designed to work in tandem with the Can-Am Spyder innovative Vehicle Stability System to provide an ultra-stable, confident ride.

706202317 - Front · 165/55R 15
706201411 - Front · 165/65R 14

705501464 · Rear
· 225/50R 15

YUASA® BATTERIES

- Absorbed Glass Mat (AGM) technology offers durability, electrical reliability, near maintenance-free performance, making it ideal for the Can-Am Spyder.
- Spill-proof design with the ability to hold its charge three times longer than conventional lead-acid batteries in stand-by mode.

410922962 - 21 Amps (YTX24HL)



NGK® SPARK PLUGS

- NGK spark plugs are recommended by BRP and ensure your Can-Am Spyder's ROTAX engine runs smoothly and delivers optimum power at all times.
- Consistent, reliable performance make it an OEM favorite.

415129670 · MR7BI-8

278002297 · DCP-R9E

219800231 · KR8Bi

707000246 · DCP-R8E



DRIVE BELTS

- High-tensile strength carbon cord and HNBR rubber construction delivers impressive durability, superior flexibility and reduced noise, while resisting abrasion.
- Tooth-side fabric composed of special low-friction fiber.

Spyder RT 2014 and up
705501304

All Spyder F3 models
705502157



XPS ENGINE OILS



XPS 4-STROKE SYNTHETIC OIL (0W40)

- The best all-year-long choice for any BRP vehicle with a 4-stroke engine.
- Full-synthetic formula made from premium oil base stocks.
- Performs consistently throughout a broad temperature range.
- Tested and proven by BRP engineers to offer the best engine protection where its use is specified.
- Wet clutch compatible.
- Protects against corrosion and rust.
- Ambient temperature operating range +40°C/+104°F to -45°C/-49°F.

779139 - 946 ml (1 quart) 779140 - 3,785 L (1 US gallon)
779214 - Europe 779199 - Europe



XPS 4-STROKE SYNTHETIC BLEND OIL (5W40)

- The warm-weather choice for any BRP vehicle with a 4-stroke engine.
- Synthetic blend formula made from premium oil base stocks.
- Performs consistently throughout a broad temperature range.
- Tested and proven by BRP engineers to offer the best engine protection where its use is specified.
- Wet clutch compatible.
- Protects against corrosion and rust.
- Ambient temperature operating range +40°C/+104°F to -35°C/-31°F.

779133 - 946 ml (1 quart) 779134 - 3,785 L (1 US gallon)
779202 - Europe 779204 - Europe



XPS OIL CHANGE KIT

- Ultra-convenient "all-in-one" oil change kit saves time and money.
- Includes XPS Synthetic or Synthetic Blend Oil, oil filter, o-rings and washer.

SM5 **SE5**
219800262 219800263
SM6, SE6
219800356



XPS CLEANERS

XPS ROADSTER CLEANING AND DETAILING KIT

- Everything needed for care and cleaning.
- Includes multi-surface XPS Metal Polish, degreasing XPS Roadster Wash, showroom shine XPS Spray Cleaner & Polish, super absorbent and machine washable XPS Microfiber Towels.

219702872



XPS MAINTENANCE PRODUCTS

XPS BRAKE FLUID

- Meets or exceeds all DOT3 and DOT4 brake fluid requirements.
- High-temperature formula resists fade, and also conditions seals and o-rings in braking system.

779151 - 12 oz. / 344 ml
779207 - Europe



XPS CARBON FREE FUEL TREATMENT

- Combination of a fuel treatment and a fuel system cleaner that can be used periodically to restore lost starting or throttle performance, as well as maintain fuel system integrity and keep internal engine parts clean.
- It treats fuel for storage and addresses the moisture problems inherent in today's Ethanol-blended fuels, keeping ferrous and soft metal parts clean and free of corrosion.
- Uses patented, state-of-the-art additives.
- Cleans valves, sticky rings and combustion chamber.

779169 - 12 oz. / 355 ml
779220 - Europe



XPS FUEL STABILIZER

- Ethanol-compatible and will stabilize fuel in your tank to keep it from breaking down and causing hard starting, throttle hesitation and poor run quality.
- Ethanol attracts moisture, and this product contains powerful anti-corrosion additives to protect fuel system components.
- Prevents problems associated with E10 fuels.

779171 - 8 oz. / 240 ml
779183 - Europe



XPS BRAKES & PARTS CLEANER

- A concentrated blend of solvents with a powerful blasting spray that effectively removes grease, grime, brake fluid and other contaminants from brake components and metal parts without the need for disassembly.
- Evaporates instantly and completely, leaving no residue to hinder performance.
- Contains no ozone depleters.

219701776



XPS ROADSTER WASH

- A biodegradable non-toxic cleaner that removes dirt and road grime better than any other cleaner.
- Simply spray on and rinse off.
- When used as directed, XPS Roadster Wash is safe for all roadster finishes.

219701703



XPS METAL POLISH

- Cleans, polishes and protects most metal surfaces, such as chrome, stainless steel, nickel, aluminum, brass, bronze, copper, platinum, magnesium and more.
- Not recommended for use on anodized or clear-coated finishes.

219701707



XPS SUSPENSION GREASE

- Designed to work specifically with the components found in Can-Am vehicles suspensions.
- It is highly stable and offers optimal lubrication at both extreme cold and high temperatures while protecting suspension components from dirt and moisture, as well as corrosion under extreme washout conditions.

779163 - 14 oz. / 397 g



XPS PRE-MIXED ANTIFREEZE/COOLANT

- XPS Antifreeze/Coolant contains the correct dilution and the necessary additives to prevent corrosion and inhibit cavitation in BRP cooling systems.
- Long-life, 5-year formula specially formulated for BRP vehicles.
- Superior heat transfer.
- Ideal replacement for vehicles that normally use a 2-year antifreeze/coolant (green).
- 5 years (orange)

779150 - 1 quart / 946 ml



XPS SPRAY CLEANER & POLISH

- Removes dirt, grease, road grime and water marks easily and quickly.
- Non petroleum based formula will not harm plastic finishes.

219702844 - 12 oz. / 340 g



XPS MICROFIBER TOWELS

- The latest in high-quality detailing towels.
- Made up of extremely fine fibers, their soft surfaces have been perfected for drying and polishing painted, gel coated and hard shiny surfaces.
- They are so absorbent they hold up to seven times their weight in water.
- Machine washable means they can be used over and over again.

· Pack of 2.
219701759



* Please contact your Can-Am Spyder dealer for suggested retail prices of oil based products. Some products may not be available or homologated in your region. Contact your dealer for more information.

CHART NEW TERRITORY

You know who you are.

You're road-trip ready and always eager to head out for a ride you'll never forget. You're all about a breathtaking adventure. Which is why you need products that meet your expectations and then some. XPS oils and lubricants answer the call. Specifically designed to optimize high performance, reliability, and long engine life for your Can-Am Spyder, XPS was developed right alongside Rotax engines. Passing the highest levels of testing; unparalleled in all conditions. Feel free on the open road. Begin your next journey at your BRP dealer.

